

# ACCU ELECTRIC MOTORS INC

USA: (888) 932-9183

CANADA: (905) 829-2505

- ✓ Over 100 years cumulative experience
- ✓ 24 hour rush turnaround / technical support service
- ✓ Established in 1993



The leading independent repairer of servo motors and drives in North America.

Visit us on the web:

[www.servo-repair.com](http://www.servo-repair.com)

[www.servorepair.ca](http://www.servorepair.ca)

[www.ferrocontrol.com](http://www.ferrocontrol.com)

[www.sandvikrepair.com](http://www.sandvikrepair.com)

[www.accuelectric.com](http://www.accuelectric.com)

**Scroll down to view your document!**

For 24/7 repair services :

USA: 1 (888) 932 - 9183

Canada: 1 (905) 829 -2505

Emergency After hours: 1 (416) 624 0386

Servicing USA and Canada

# Panasonic

## AC Servo Motor Driver MINAS S-series

## Operating Manual



Be sure give this instruction manual to the user.

- Thank you very much for your buying Panasonic AC Servo Motor Driver,A-series.
- Before use, read through this manual to ensure proper use. Keep this manual at an easily accessible place so as to be referred anytime as necessary.

# Table of Contents

---

## Before Use

Safety Precautions .....	4
Introduction .....	8
After Opening the Package .....	8
Check the Model Number of Amplifier .....	8
Check the Model Number of Motor .....	9
Check the Combination of Amplifier and Motor .....	10

Parts Description .....	12
Amplifier .....	12
Motor .....	13
Installation .....	14
Amplifier .....	14
Motor .....	16

---

## Preparations and Adjustments

System Configuration and Wiring .....	1 8
General Wiring Diagram .....	18
List of Available Components .....	20
Main Circuits .....	22
CN SIG Connector	
For Encoder .....	23
CN SER Connector .....	24
CN I/F Connector	
For Controller .....	25
CN MON Connector .....	35
Parameter Setting .....	36
Overview .....	36
Parameter Groups and Listing .....	36
Setting the Parameters .....	41
Overview of PANATERM. ....	41
How to Connect .....	41

Trial Run .....	44
Inspections before Trial Run .....	44
Operation with	
CN I/F Connected .....	45
Adjustments .....	50
Purposes of Gain Adjustments .....	50
Types of Gain Adjustments .....	50
How to Adjust Gain .....	52
How to Use	
"Normal Auto-Gain" Tuning .....	53
How to Use "Real Time	
Auto-Gain" Tuning .....	54
How to Adjust Gain Manually .....	55
Gain Tuning Using	
Gain Adjustment Rotary Switch .....	58
To reduce the mechanical	
resonance .....	59

---

## Important Information

Protective Functions ..... 60  
Maintenance and  
Inspections ..... 6 6

Troubleshooting  
..... 68  
After-Sale Service  
..... Back cover

---

## Appendixes

Conformance to EC Directives and UL Standards ..... App. 2  
Holding Brake ..... App. 6  
Dynamic Brake ..... App. 8  
Timing Chart ..... App. 10  
Acceptable Loads on Output Shaft ..... App. 14  
Homing Operation (Precautions) ..... App. 15



Recommended Parts ..... App. 47  
Dimensions ..... App. 48  
Characteristics ..... App. 53  
Specifications ..... App. 54  
Details of Parameters ..... App. 16  
Optional Parts ..... App. 38

# Safety Precautions



(Important)

Observe the following precautions in order to avoid injuries of operators and other persons, and mechanical damages.

- The following DANGER and CAUTION symbols are used according to the level of dangers possibly occurring if you fail to observe the instructions or precautions indicated.

 <b>DANGER</b>	Indicates a potentially hazardous situation which, if not avoided, will result in death or serious injury.
 <b>CAUTION</b>	Indicates a potentially hazardous situation which, if not avoided, will result in minor or moderate injury and physical damage.

- The following symbols indicate what you are not allowed to do, or what you must observe.

	This symbol indicates that the operation is prohibited.
	This symbol indicates that the operation must be performed without fail.

## DANGER

An over-current protection, earth leakage breaker, over-temperature protection and emergency stop should be installed.



Failure to observe this instruction could result in electric shocks, injuries and/or fire.

Don't insert your hands in the amplifier.



Failure to observe this instruction could result in burns and/or electric shocks.

Install the amplifier securely to prevent fire hazard and personal injury resulting from earthquake.



Failure to observe this instruction could result in electric shocks, injuries and/or fire.

Be sure to check safety after occurrence of earthquake.



Failure to observe this instruction could result in electric shocks, injuries and/or fire.

# DANGER

Don't touch the rotating part of the motor in motion.

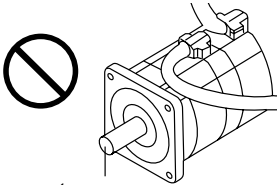

Rotating part  
Failure to observe this instruction could result in injuries.

Don't subject the product to water splash, corrosive gases, flammable gases and combustible things.



Failure to observe this instruction could result in fire.

Do not expose the cables to sharp edges, excessive pressing forces, heavy loads or pinching forces.



Failure to observe this instruction could result in electric shocks, malfunction and/or damages.

Perform the transportation, wiring and inspection at least 10 minutes after the power off.



Failure to observe this instruction could result in electric shocks.

Always ask to an electrical engineer for wiring.

Ground the earth terminal of the amplifier.



Failure to observe this instruction could result in electric shocks.

Install an external emergency stop device so that you can shut off the power in any emergency cases.



Failure to observe this instruction could result in injuries, electric shocks, fire, malfunction and/or mechanical damages.

## Caution

Use the motor and amplifier in the specified combination.



Failure to observe this instruction could result in fire.

Execute the trial operations with the motor fixed but without motor load connected. Connecting a load to the motor is possible only after successful trial operation.



Failure to observe this instruction could result in injuries.

If an error occurs, remove the causes for the error and secure the safety before restarting the operation.



Failure to observe this instruction could result in injuries.

Don't touch the motor, amplifier or its regenerative discharge resistor, since they become hot.



Failure to observe this instruction could result in burns.

Avoid extreme adjustment or change. Avoid an operation which causes unstable action.



Failure to observe this instruction could result in injuries.

Don't modify, dismantle or repair the amplifier.



Failure to observe this instruction could result in fire, electric shocks and/or injuries.

# ⚠ Caution

Don't hold the cables or motor shaft when transporting the motor.



Failure to observe this instruction could result in injuries.

After recovery from the power failure, the equipment may restart suddenly. Don't approach the equipment



Failure to observe this instruction could result in injuries.

\*Provide appropriate settings as a preparedness against the accidental restart of the machine in order to ensure the safety of personnel.

Don't block the heat dissipation hole or insert foreign matters in it.



Failure to observe this instruction could result in electric shocks, injuries and/or fire.

Observe the voltage specified.



Failure to observe this instruction could result in electric shocks, injuries and/or fire.

Make sure that the wirings are made correctly.



Failure to observe this instruction could result in electric shocks, injuries.

This equipment should be treated as an industrial waste when it is disposed of.

Do not turn on/off the main power frequently. Failure to observe this instruction could result in malfunctions.

# Introduction

## After Opening the Package

- Make sure that the product is what you have ordered.
- Check whether the product has been damaged or not during transportation.

If the product is not correct, or it has been damaged, contact dealer or sales agent.

## Check the Model of Amplifier

### Name plate

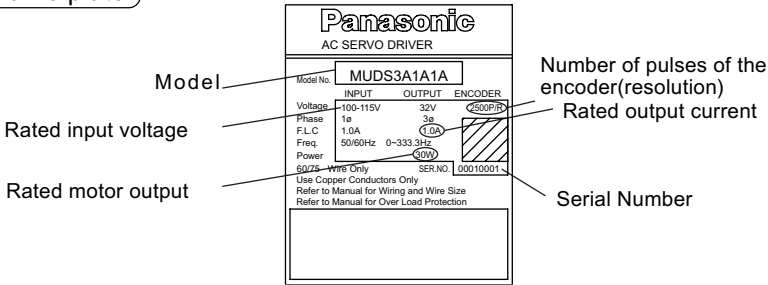

### Model Designation

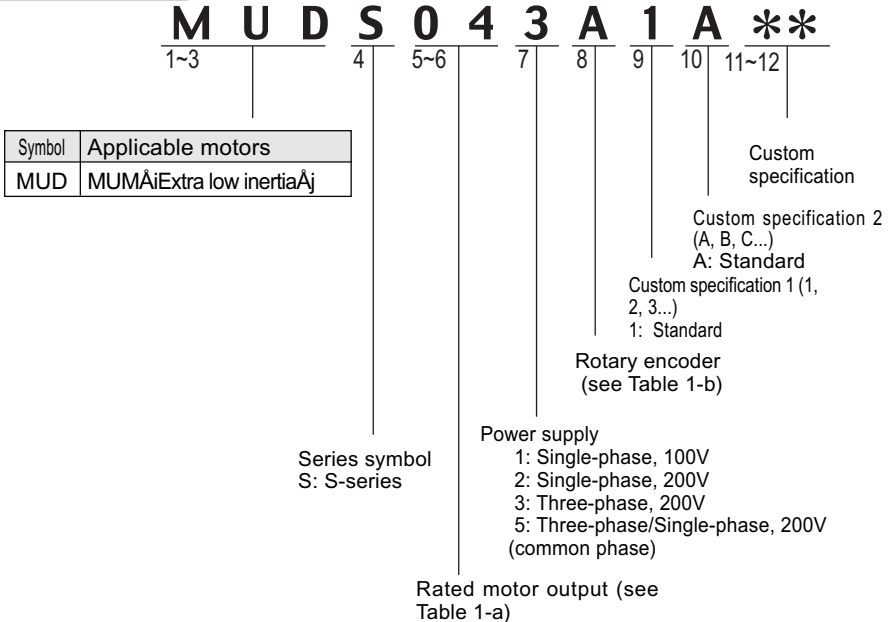

# Check the Model of Motor

## Name plate

**Labels:** Type, Rated output, Revolution rating, Serial No.

<b>Panasonic</b>		CONT. TORQUE	0.64 Nm
AC SERVO MOTOR	RATING	S1	
Model No. MUMS042A1A	INS. CLASS	B (70V) A (UL)	
INPUT 30AC 92 V	IP55	CONNECTION	▲
1.6 A	RATED OUTPUT	SER No.	00010001
0.2 kW	RATED FREQ.		
200 Hz	RATED REV.		
3000 r/min			
Matsushita Electric Industrial Co., Ltd. Made in Japan			

## Model Designation

M U M S 0 4 2 A 1 A \*\*

1~3      4      5~6      7      8      9      10      11~12

Symbol	Type
MUM	Super low inertia

Custom specification 2

Motor structure (see Table 1-c)

Custom specification 1  
1: Standard

Rotary encoder (see Table 1-b)

Voltage  
1: 100V  
2: 200V  
Z: 100/200V

Series symbol  
S: S-series

Rated output (see Table 1-a)

**Table 1-a** Rated Motor Output

Symbol	Rated output	Symbol	Rated output
3A	30W	02	200W
5A	50W	04	400W
01	100W	08	750W

**Table 1-b** Rotary Encoder

Symbol	Specifications			
	Type	No. of pulses	Resolution	Lead wire
A	Incremental	2500P/r	10000	11-wire

**Table 1-c** Motor Structure

Oil seal	Brake	Shaft	
		Straight	Key way
None	None	A	E
	Yes	B	F
Yes	None	C	G
	Yes	D	H

Σ Specifications with the shaft provided with key way are standard.

# Introduction

---

## Check the Combination of Amplifier and Motor

The amplifier has been designed for use in combination with the specified motors only. Check the specifications (Series symbol, output rating, voltage rating and encoder type) of the motor you want to use.

With the incremental type encoder: 2500P/r

Power supply for amplifier	Amplifier	Amplifier type	Motor					
			Series symbol	Motor type	Voltage	Output rating	Revolution rating	Encoder type
1-phase, 100V	MUDS3A1A1A	Type1	MUMS	MUMS3AZ*****	100V	30W	3000r/min	Incremental 2500P/r, 11 wires
	MUDS5A1A1A			MUMS5AZ*****		50W		
	MUDS011A1A	MUMS011A*****		100W				
	MUDS021A1A	MUMS021A*****		200W				
	MUDS041A1A	MUMS041A*****		400W				
1-phase, 200V	MUDS022A1A	Type2		MUMS022A*****	200V	200W		
	MUDS042A1A	Type3		MUMS042A*****		400W		
3-phase/1-phase, 200V	MUDS3A5A1A	Type1		MUMS3AZA*****	200V	30W		
	MUDS5A5A1A			MUMS5AZA*****		50W		
	MUDS015A1A			MUMS012A*****		100W		
3-phase, 200V	MUDS023A1A	Type2	MUMS022A*****	200V	200W			
	MUDS043A1A		MUMS042A*****		400W			
	MUDS083A1A	Type3	MUMS082A*****		750W			

Before Use

# Parts Description

## Amplifier

Example: MUDS023A1A

Example: MUDS042A1A

(3-phase, 200V 200W: Type 1)

(1-phase, 200V 400W: Type 3)

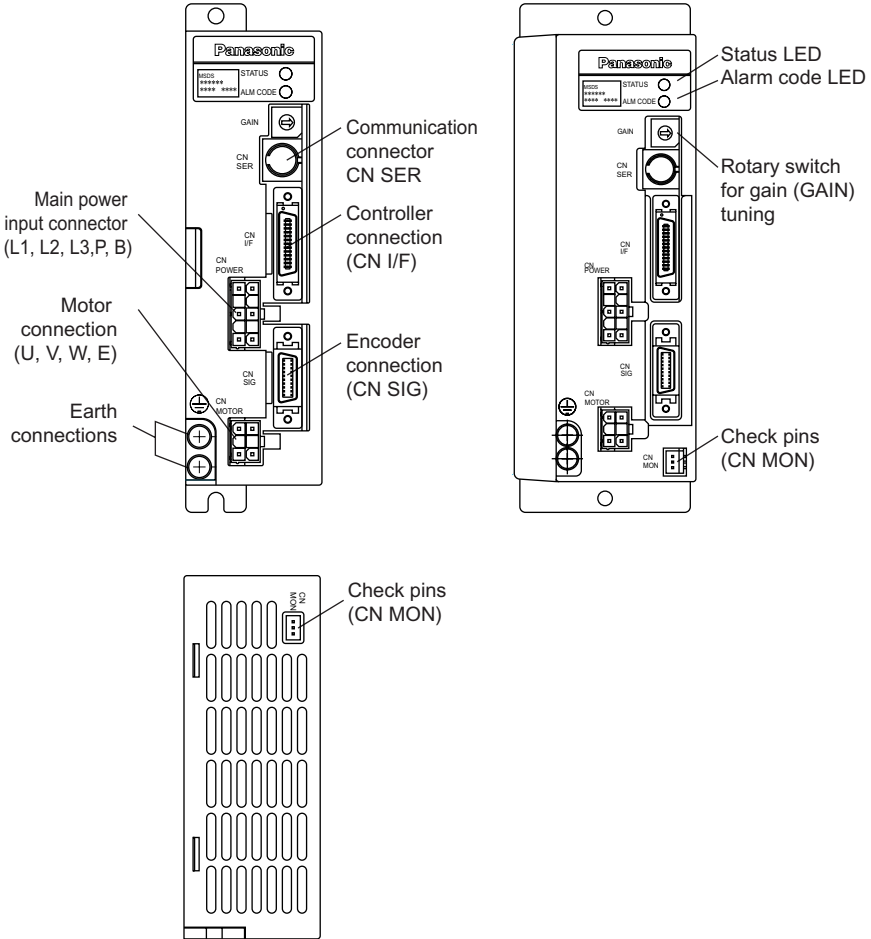

### <Notes>

For detailed information for each of motor types, see the drawings in the Appendix (App.50 to 52).

Example: Super Low-Inertia Motor (MUMS Series, 400W)

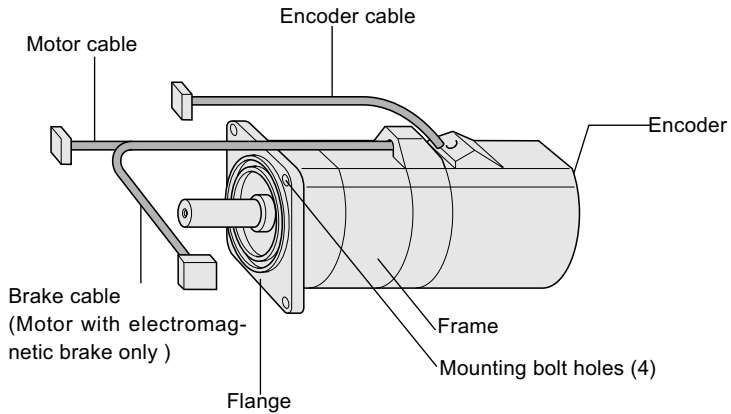

<Notes>

For detailed information for each of motor types, see the drawings in the Appendix (App.48 & 49).

# Installation

The amplifier and motor should be properly installed to avoid failures, mechanical damages and injuries.

## Amplifier

### Location

- Indoors, where the amplifier is not subjected to rain water and direct sun beams. Note that the amplifier is not a waterproof structure.
- Avoid the place where the amplifier is subjected to corrosive gases, flammable gases, grinding liquids, oil mists, iron powders and cutting particles.
- Place in a well-ventilated, and humid- and dust-free space.
- Place in a vibration-free space.

### Environmental Conditions

Item	Conditions
Ambient temperature	0 to 55 °C (free from freezing)
Ambient humidity	Not greater than 90%RH (free from condensation)
Storage temperature	-20 to 80 °C (free from condensation)
Storage humidity	Not greater than 90%RH (free from condensation)
Vibration	Not greater than 5.9m/s <sup>2</sup> (0.6G) at 10 to 60 Hz
Altitude	Not greater than 1000 m

### How to Install

- This is a rack-mount type.

Place the amplifier vertically. Allow enough space surrounding for ventilation.

Front panel mount type (recessed)

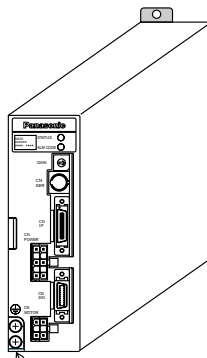

Earth connection (M4 screw) tightening torque shall not exceed 0.39 – 0.59 N·m.

### Mounting Direction and Space Requirements

- Allow enough space to ensure enough cooling.
- Install fans to provide a uniform distribution of temperature in the control box.  
The airflow of fan is more than  $0.43\text{m}^3/\text{min}$ . And it should be located 10 cm away from the amplifier.
- Observe the environmental requirements for the control box, mentioned in the previous page.

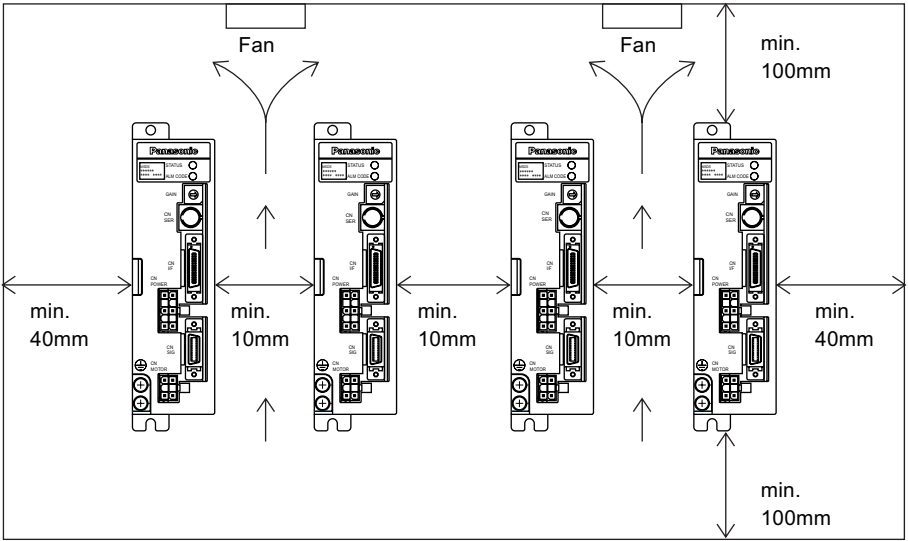

# Installation

## Motor

### Location

- Indoors, where the amplifier is not subjected to rain water and direct sun beams.
- Avoid the place where the amplifier is subjected to corrosive gases, flammable gases, grinding liquids, oil mists, iron powders and cutting particles.
- Place in a well-ventilated, and humid- and dust-free space.
- Easy maintenance, inspections and cleaning is also important.

### Environmental Conditions

Item	Conditions	
Ambient temperature	0 to 40 °C (free from freezing)	
Ambient humidity	Not greater than 85%RH (free from condensation)	
Storage temperature	-20 to 80 °C (free from freezing)	
Storage humidity	Not greater than 85%RH (free from condensation)	
Vibration	Motor only	49 m/s <sup>2</sup> (5G) or less at rotation, 24.5 m/s <sup>2</sup> (2.5G) or less at rest
	With gear (At rotation)	High precision and normal type: 24 m/s <sup>2</sup> (2G) or less
		Standard type: 49 m/s <sup>2</sup> (5G) or less
Shock	Motor only	98 m/s <sup>2</sup> (10G) or less
	With gear	High precision and normal type: 98 m/s <sup>2</sup> (10G) or less
		Standard type: 24 m/s <sup>2</sup> (2G) or less

### How to Install

The motor can be installed either vertically or horizontally. Observe the following notes.

- Horizontal mounting
- Place the motor with the cable outlet facing down to prevent the entry of oil and water.
- Vertical mounting
- If a motor is coupled with a reduction gear, use a motor equipped with oil seal so that oil in the reduction gear may not enter into the motor.

### Oil and Water Protections

- This motor(IP65 rating) can be used where it is subjected to water and/or oil drops, but is not water - or oil - proof. Therefore, the motors should not be placed or used in such environment.
- If the motor is coupled with a reduction gear, use the motor with oil seals to prevent the reduction gear oil from entering into the motor.
- Don't use the motor with the cables being immersed in oil or water.

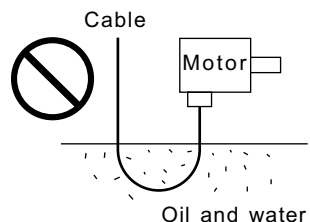

### Cable: Stress Relieving

- Make sure that the cables are not subjected to moments or vertical loads due to external bending forces or self-weight at the cable outlets or connections.
- In case the motor is movable, secure the cable (proper one supplied together with the motor) to a stationery part (e.g. floor), and it should be extended with an additional cable which should be housed in a cable bearer so that bending stresses can be minimized.
- Make the bending radius of cables as large as possible.  
(Minimum bend radius: 20 mm)

### Permissible Shaft Load

- Make sure that both of radial and thrust load to be applied to the motor shaft during installation and running, are within the specified value of each model.
- Pay extra attention to installing a rigid coupling (especially an excess bending load which may cause the damages and/or wear of the shaft and bearings).
- Flexible coupling is recommended in order to keep the radial load smaller than the permissible value, which is designed exclusively for servo motors with high mechanical stiffness.
- For the permissible shaft load, see "Allowable Shaft Loads Listing" in Appendix.

### Installation Notes

- Don't hit the shaft with a hammer directly while attaching/detaching the coupling to the motor shaft. (otherwise the encoder at the opposite end of the shaft will be damaged).
- Try perfect alignment between shafts (misalignment may cause vibration, and damages of the bearings).

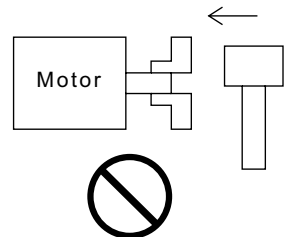

# System Configuration and Wiring

## General Wiring Diagram

### • Main Circuits

#### Non-Fuse Breaker (NFB)

Used to protect the power lines:  
overcurrent will shut off the circuit.

#### Noise Filter (NF)

Prevents the external noise from the power line, and reduces the effect of the noises generated by the servo motor.

#### Magnetic Contactor (MC)

Turns on/off the main power of the servo motor.

Used together with a surge absorber.

#### Reactor (L)

Reduces the harmonic current in the main power.

#### Terminals P and B

• In case of use under large regenerative energy, connect an external regenerative discharge resistor to P and B terminals.

#### <Notes>

Where residual-current-operated protective device (RCD) is used for protection in case of direct or indirect contact. Only RCD of Type B is allowed on supply side of this Electronic Equipment (EE).

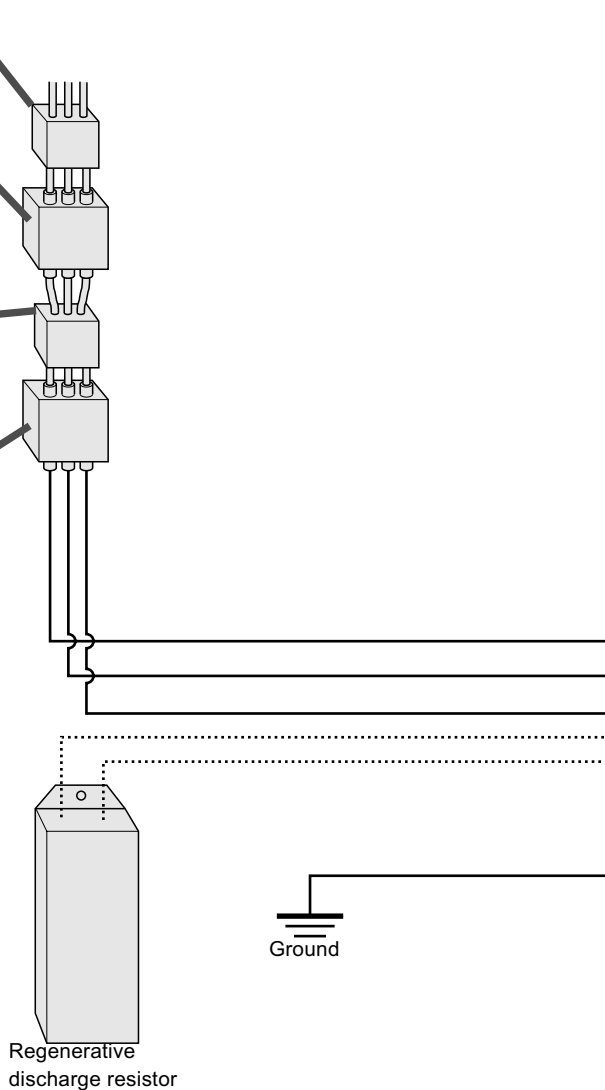

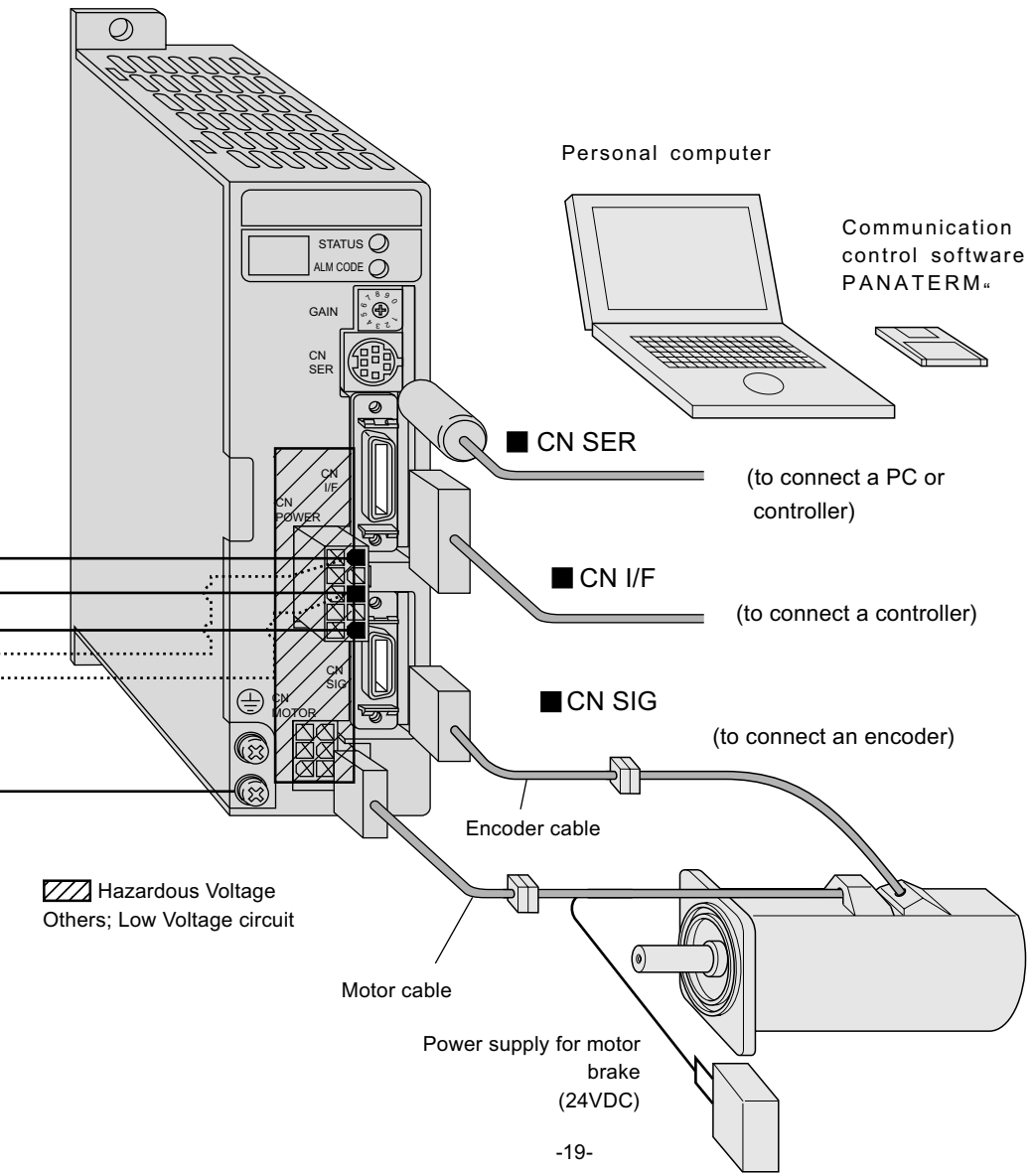

# System Configuration and Wiring

## List of Available Components

Amplifier			Required Power (at the rated load)	Circuit breaker (rated current)	Noise filter	Magnetic contactor (contacts)	Main circuit wire diameter (L1 L2, L3, U, V, W, E)
Series	Voltage	Output					
MUDS	1-phase, 100V	30~50W	Approx. 0.3kVA	B K 2 5 1 (5A)	DVOP1441	BMFT61041N (3P+1a)	0.75mm <sup>2</sup> ~ 0.85mm <sup>2</sup> AWG 18
		100W	Approx. 0.4kVA				
		200W	Approx. 0.5kVA				
		400W	Approx. 1.0kVA				
	*1-phase, 200V	30~50W	Approx. 0.3kVA	B K 3 5 1 (5A)	DVOP1441	BMFT61541N (3P+1a)	
		100W					
	1-phase, 200V	200W	Approx. 0.5kVA	B K 3 1 0 1 (10A)	DVOP1442		
		400W	Approx. 0.9kVA				
	*3-phase, 200V	30~50W	Approx. 0.3kVA	B K 3 5 1 (5A)	DVOP1441	MMFT61042N (3P+1a)	
		100W					
	3-phase, 200V	200W	Approx. 0.5kVA	BK3101(10A)			
		400W	Approx. 0.9kVA				
750W		Approx. 1.3kVA					
			B K 3 1 5 1 (15A)	DVOP1442			

As these models with \* are used for both 1-phase 200V and 3-phase 200V, make a choice according to the power source.

- When these wires are used, wire length between circuit breaker and amplifier should be less than 3 m.
- The model numbers of circuit breaker and magnetic contactors shown in the above list are manufactured by Matsushita Electric Works, Ltd.
- Use the circuit breaker as shown in App.3 to meet relevant EC Directives.
- The model number of noise filters (options) shown in the above are manufactured by Okaya Electric Industries Co., Ltd.

### <Notes>

- CN POWER, CN MOTOR and earth terminals  
Wires should be copper conductors of a temperature rating of 60°C or above.
- Earth wire diameter should be 2.0 mm<sup>2</sup> (AWG14) or larger.
- Please also consider the electrochemical potentials between metal conductor including closed loop terminals.  
The electrochemical potentials shall be less than 0.6V.

### For 3-phase 200VAC

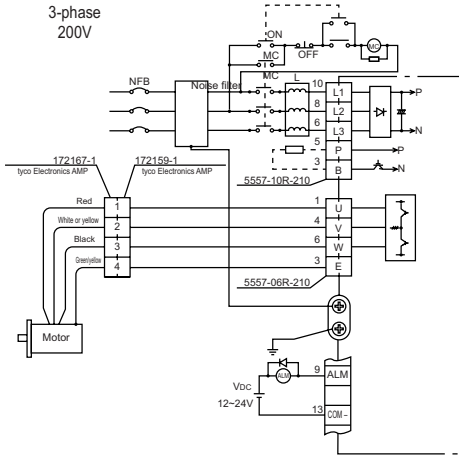

### For 1-phase 100V/200V

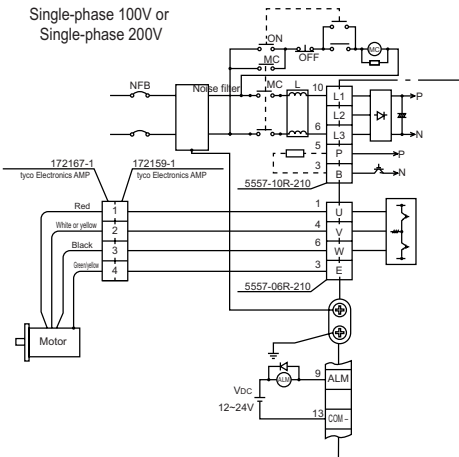

<Note>

- In case that alarm occurs, construct the circuits so that the main power is switched of.

# System Configuration and Wiring

## Main Circuits

Always ask to an electric engineer for wiring.

Don't turn on the main power until the wiring and connectings are completed, to avoid electric shocks.

### Wiring Instructions

- Make necessary connections.  
For wire diameter, see List of Available Components (page 20).
- Securely insert connectors.

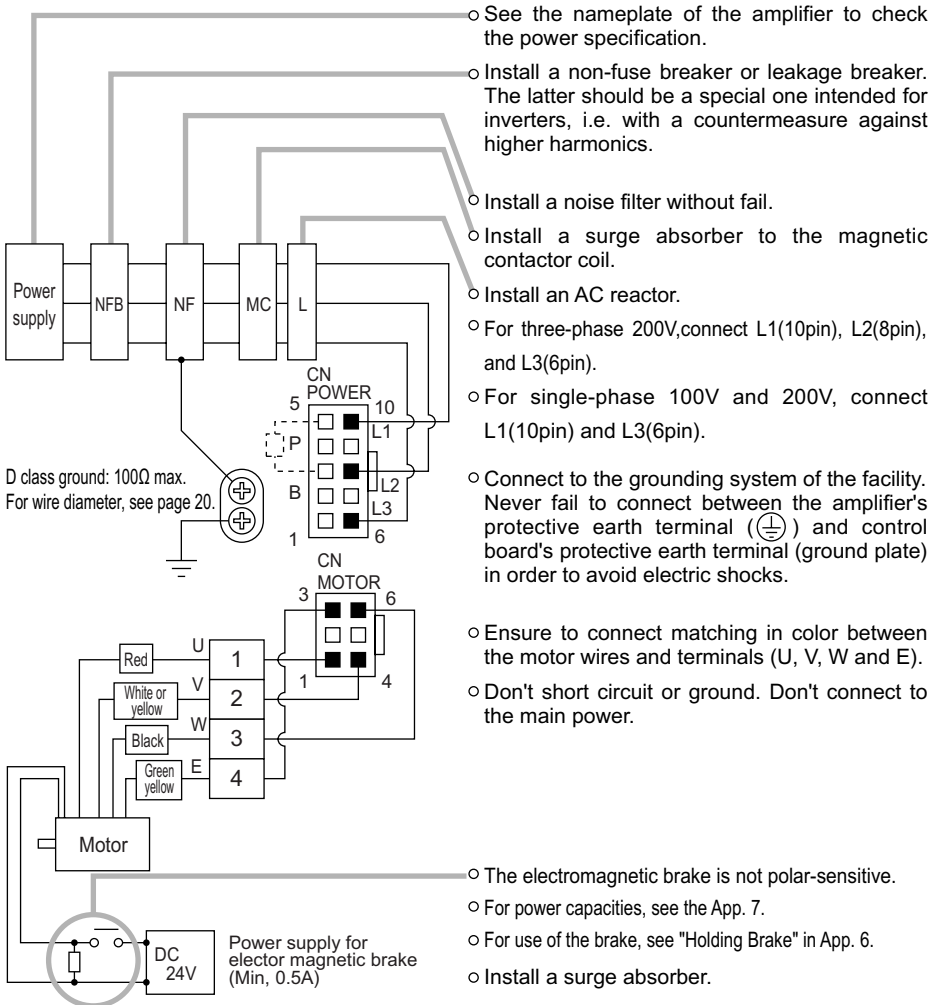

# CN SIG Connector (For Encoder)

## Wiring Instructions

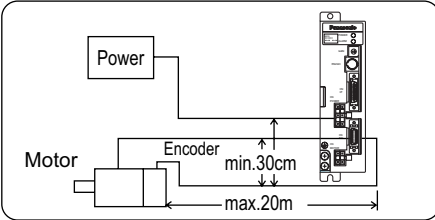

- The cable length between the amplifier and motor should be max. 20 m. If you use a longer cable, contact the dealer or sales agent.
- Separate these wiring min. 30 cm from the main circuit wires. Don't lay these wires in the same duct of the mains or bundle with them.

## Wiring Diagrams

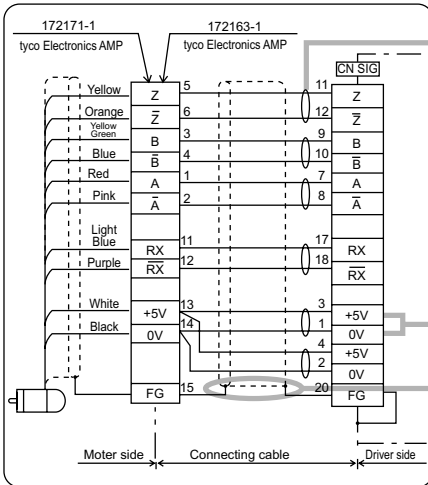

When you prepare your own connecting cables see the "Optional Parts" for connectors, and

- 1) Follow the wiring diagram and use the
- 2) Wire material: 0.18 mm<sup>2</sup> (AWG24) or more, shielded twist-paired wire with an enough bending durability,
- 3) Signal/power paired wires should be of a twist-paired type.
- 4) Shield:
  - The shield at the amplifier side should be connected to Pin 20 (FG) of CN SIG Connector.
  - The shield at the motor side should be connected to: connector of 15 pins type
- 5) If the cable is longer than 10 m, the encoder power line (+5V and 0V) should be dual per the figure shown left.
- 6) Other terminals should be left unconnected.

# System Configuration and Wiring

## CN SER Connector

### For RC232C communications

Connect a personal computer to the amplifier with RS232C at 1:1, and use the communication control software "PANATERM" (Option). Operate "PANATERM" on the personal computer. Convenient functions of high operability can be obtained such as monitor and parameter setting and setting change and waveform graphic display.

### Connection

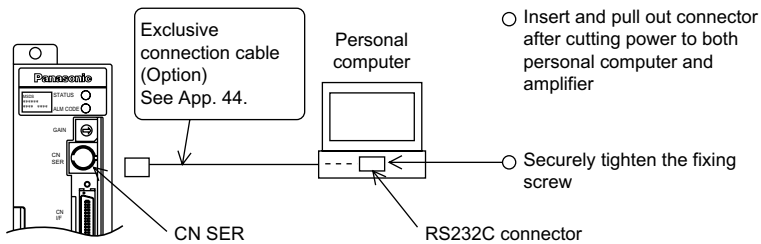

# List of Available Components

## CN I/F Connector (For Controller)

### Wiring Instructions

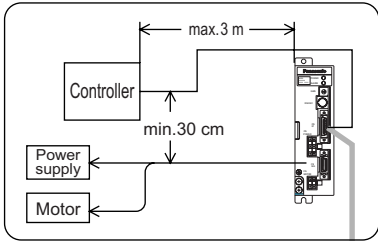

- Place the peripheral devices such as the controller max. 3 m away from the amplifier.
- Separate these wiring min. 30 cm from the main circuit wires. Don't lay these wires in the same duct of the mains or bundle with them.

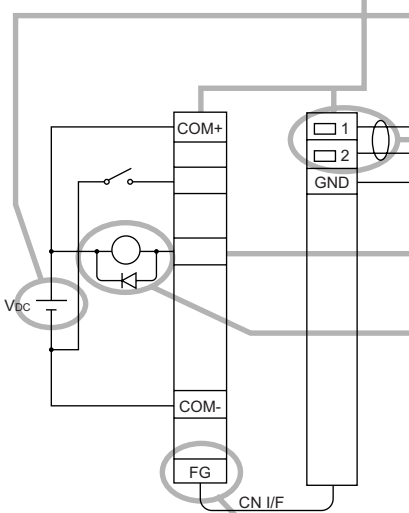

- The control power (VDC) between COM+ and COM- should be supplied by the customer (recommended voltage: +12VDC to +24VDC).
- Use a shielded twist-paired type for the wiring of pulse input, encoder signal output, etc.
- Do not apply power higher than 24V or 50mA to control signal output terminal.
- If you directly activate a relay using the control signal, install a diode in parallel to the relay as shown in the left figure. Without a diode or with it but placed in the opposite direction, the amplifier will be damaged.
- The Frame Ground (FG) is connected to an earth terminal in the amplifier.

Preparations and Adjustments

### • CN I/F Connector Specifications

Receptacle on the amplifier side	Connector to controller side		Manufacturer
	Part description	Part No.	
10226-52A2JL	Solder type plug (Soldering type)	10126-3000VE	Sumitomo three M
	Connector cover	10326-52A0-008	

• The CN I/F pins assignment is shown in "Optional Parts" in Appendix.

# System configuration and wiring

## Circuits Available for Typical Control Modes

### • CN I/F Wiring for Position Control

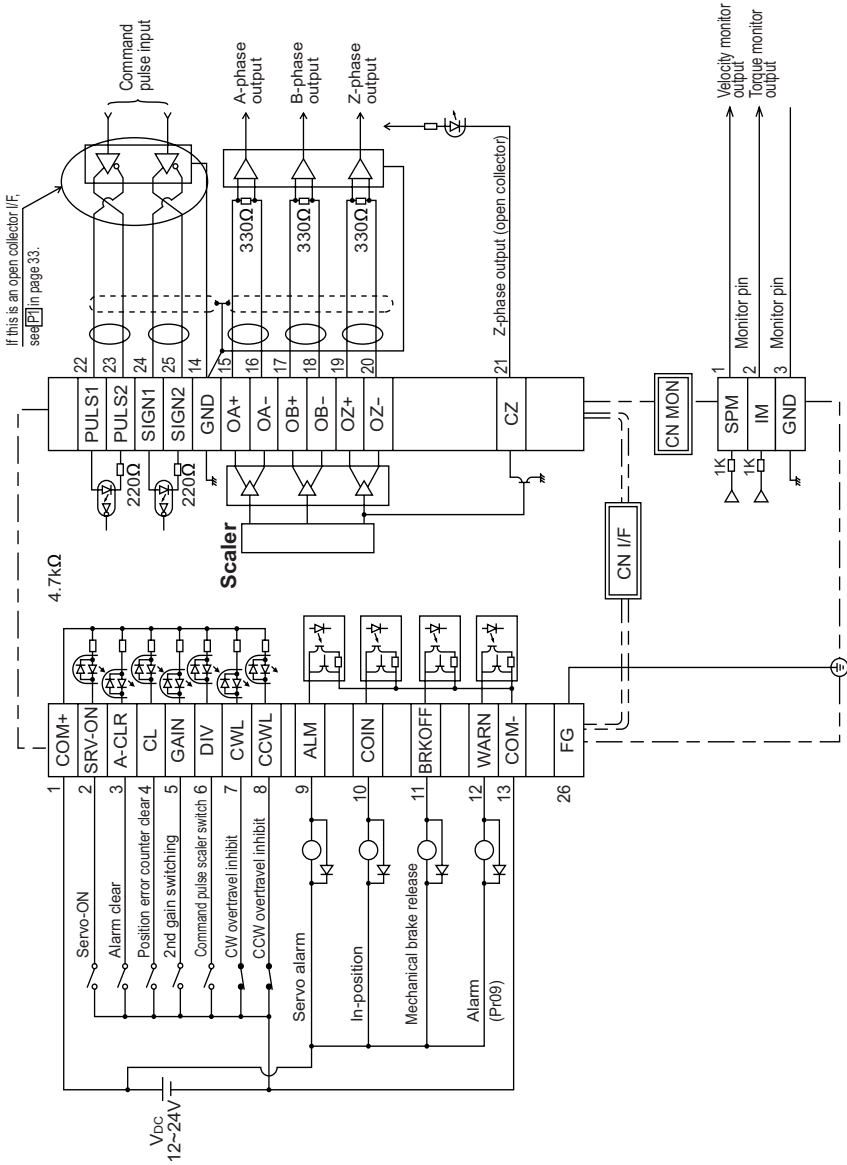

• CN I/F Wiring for Internal Velocity Control

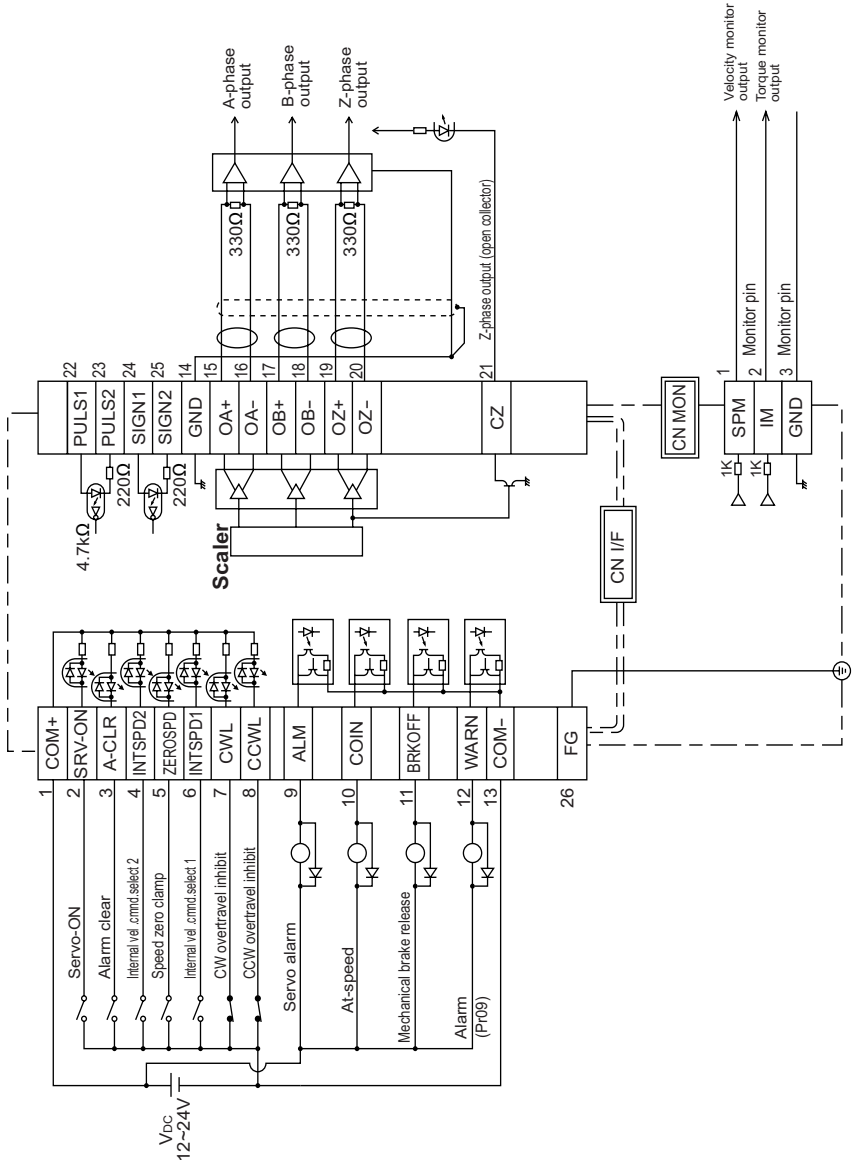

# System configuration and wiring

## CN I/F Connector

### Input Signals (Common) and their Functions

Signal	Pin No.	Symbol	Function	I/F circuit
Control signal power (+)	1	COMA{	<ul style="list-style-type: none"> <li>Connect to (+) of an external power supply(12VDC to 24VDC).</li> <li>Use power supply of 12V±10%∧`24V±10%</li> </ul>	∧∧∧
Control signal power (-)	1 3	COMA	<ul style="list-style-type: none"> <li>Connect to (-) of an external power supply(12VDC to 24VDC).</li> <li>The required capacity depends on the I/O circuit configuration. 0.5A or larger is recommended.</li> </ul>	
Servo-ON	2	SRV-ON	<ul style="list-style-type: none"> <li>When this signal is connected to COM-, the dynamic brake will be released and the amplifier is enabled. (Servo-ON).</li> </ul> <p>&lt;Notes&gt;</p> <ol style="list-style-type: none"> <li>This signal becomes effective about two seconds after power on (see the Timing chart).</li> <li>Don't use this Servo-ON or Servo-OFF signal to turn on or off the motor. (See App.8)</li> </ol> <ul style="list-style-type: none"> <li>Allow at least 100ms delay after the amplifier is enabled before any command input is entered.</li> <li>By opening the connection to COM- , the amplifier will be disabled(Servo-OFF) and the current flow to the motor will be inhibited.</li> <li>Operation of the dynamic brake and clearing action of the position error counter can be selected using Pr69 (Sequence under Servo-OFF).</li> </ul>	<span style="border: 1px solid black; padding: 2px;">SI</span> page 33
Alarm clear	3	A-CLR	<ul style="list-style-type: none"> <li>If the COM- connection is kept closed for more than 120 ms, the alarm status will be cleared.</li> <li>Some alarms cannot be cleared by this input. For details, see Protective Functions on page 60.</li> </ul>	<span style="border: 1px solid black; padding: 2px;">SI</span> page 33
Position error counter clear/Internal command velocity selection 2	4	CL/ INTSPD2	The function differs depending on the control mode.	<span style="border: 1px solid black; padding: 2px;">SI</span> page 33
		Position control	<ul style="list-style-type: none"> <li>Clears the position error counter. Connect to COM- to clear the counter.</li> <li>Use Pr4D to select the clear mode (0 Default: level 1: Edge)</li> </ul>	
		Internal velocity control	<ul style="list-style-type: none"> <li>The internal velocity selection 2 (input) is valid. 4 kinds of velocity settings are available by combination with DIV/ INTSPD1 input. See control mode setting Pr02 (APP. 16).</li> </ul>	

Signal	Pin No.	Symbol	Function	I/F circuit																						
Gain switching/ Speed zero clamp	5	GAIN/ ZEROSPD	The function differs depending on the control mode.	<div style="border: 1px solid black; padding: 2px; display: inline-block;">SI</div> page 33																						
			<table border="1" style="width: 100%; border-collapse: collapse;"> <tr> <td style="width: 15%;">Position control</td> <td> <ul style="list-style-type: none"> <li>The functions depend on the value of Pr30.</li> <li>Gain switching input results. Input for switching PI/P operation and No. 1/No. 2 gains.</li> </ul> <table border="1" style="width: 100%; border-collapse: collapse; margin-top: 5px;"> <thead> <tr> <th style="width: 10%;">Pr30 value</th> <th style="width: 15%;">Connection to COM-</th> <th style="width: 75%;">Function</th> </tr> </thead> <tbody> <tr> <td rowspan="2">0 <small>(Default)</small></td> <td>Open</td> <td>Speed loop:PI(ProportionalAEIntegration) operation</td> </tr> <tr> <td>Close</td> <td>Speed loop: P (Proportion) operation</td> </tr> <tr> <td rowspan="2">1</td> <td>Open</td> <td>#1 gain selection (Pr10, 11, 12, 13, 14)</td> </tr> <tr> <td>Close</td> <td>#2 gain selection (Pr 18, 19, 1A, 1B, 1C)</td> </tr> <tr> <td colspan="3">At Pr31 value of 2</td> </tr> </tbody> </table> </td> </tr> <tr> <td>Internal velocity control</td> <td> <ul style="list-style-type: none"> <li>For No.2 Gain change Function, see Protective Adjustments on page 57.</li> <li>Speed zero clamp input results. With COM- open, the velocity command is considered zero.</li> <li>This input can be made disabled using Pr06.</li> <li>Default: Contact is set. With COM- open, the velocity command is considered zero.</li> </ul> <table border="1" style="width: 100%; border-collapse: collapse; margin-top: 5px;"> <thead> <tr> <th style="width: 15%;">Pr06 value</th> <th style="width: 85%;">Meaning</th> </tr> </thead> <tbody> <tr> <td>0</td> <td>ZEROSPD is disabled.</td> </tr> <tr> <td>1 <small>[Default]</small></td> <td>ZEROSPD is enabled</td> </tr> </tbody> </table> </td> </tr> </table>		Position control	<ul style="list-style-type: none"> <li>The functions depend on the value of Pr30.</li> <li>Gain switching input results. Input for switching PI/P operation and No. 1/No. 2 gains.</li> </ul> <table border="1" style="width: 100%; border-collapse: collapse; margin-top: 5px;"> <thead> <tr> <th style="width: 10%;">Pr30 value</th> <th style="width: 15%;">Connection to COM-</th> <th style="width: 75%;">Function</th> </tr> </thead> <tbody> <tr> <td rowspan="2">0 <small>(Default)</small></td> <td>Open</td> <td>Speed loop:PI(ProportionalAEIntegration) operation</td> </tr> <tr> <td>Close</td> <td>Speed loop: P (Proportion) operation</td> </tr> <tr> <td rowspan="2">1</td> <td>Open</td> <td>#1 gain selection (Pr10, 11, 12, 13, 14)</td> </tr> <tr> <td>Close</td> <td>#2 gain selection (Pr 18, 19, 1A, 1B, 1C)</td> </tr> <tr> <td colspan="3">At Pr31 value of 2</td> </tr> </tbody> </table>	Pr30 value	Connection to COM-	Function	0 <small>(Default)</small>	Open	Speed loop:PI(ProportionalAEIntegration) operation	Close	Speed loop: P (Proportion) operation	1	Open	#1 gain selection (Pr10, 11, 12, 13, 14)	Close	#2 gain selection (Pr 18, 19, 1A, 1B, 1C)	At Pr31 value of 2			Internal velocity control	<ul style="list-style-type: none"> <li>For No.2 Gain change Function, see Protective Adjustments on page 57.</li> <li>Speed zero clamp input results. With COM- open, the velocity command is considered zero.</li> <li>This input can be made disabled using Pr06.</li> <li>Default: Contact is set. With COM- open, the velocity command is considered zero.</li> </ul> <table border="1" style="width: 100%; border-collapse: collapse; margin-top: 5px;"> <thead> <tr> <th style="width: 15%;">Pr06 value</th> <th style="width: 85%;">Meaning</th> </tr> </thead> <tbody> <tr> <td>0</td> <td>ZEROSPD is disabled.</td> </tr> <tr> <td>1 <small>[Default]</small></td> <td>ZEROSPD is enabled</td> </tr> </tbody> </table>	Pr06 value	Meaning
Position control	<ul style="list-style-type: none"> <li>The functions depend on the value of Pr30.</li> <li>Gain switching input results. Input for switching PI/P operation and No. 1/No. 2 gains.</li> </ul> <table border="1" style="width: 100%; border-collapse: collapse; margin-top: 5px;"> <thead> <tr> <th style="width: 10%;">Pr30 value</th> <th style="width: 15%;">Connection to COM-</th> <th style="width: 75%;">Function</th> </tr> </thead> <tbody> <tr> <td rowspan="2">0 <small>(Default)</small></td> <td>Open</td> <td>Speed loop:PI(ProportionalAEIntegration) operation</td> </tr> <tr> <td>Close</td> <td>Speed loop: P (Proportion) operation</td> </tr> <tr> <td rowspan="2">1</td> <td>Open</td> <td>#1 gain selection (Pr10, 11, 12, 13, 14)</td> </tr> <tr> <td>Close</td> <td>#2 gain selection (Pr 18, 19, 1A, 1B, 1C)</td> </tr> <tr> <td colspan="3">At Pr31 value of 2</td> </tr> </tbody> </table>	Pr30 value	Connection to COM-	Function	0 <small>(Default)</small>	Open	Speed loop:PI(ProportionalAEIntegration) operation	Close	Speed loop: P (Proportion) operation		1	Open	#1 gain selection (Pr10, 11, 12, 13, 14)	Close		#2 gain selection (Pr 18, 19, 1A, 1B, 1C)	At Pr31 value of 2									
Pr30 value	Connection to COM-	Function																								
0 <small>(Default)</small>	Open	Speed loop:PI(ProportionalAEIntegration) operation																								
	Close	Speed loop: P (Proportion) operation																								
1	Open	#1 gain selection (Pr10, 11, 12, 13, 14)																								
	Close	#2 gain selection (Pr 18, 19, 1A, 1B, 1C)																								
At Pr31 value of 2																										
Internal velocity control	<ul style="list-style-type: none"> <li>For No.2 Gain change Function, see Protective Adjustments on page 57.</li> <li>Speed zero clamp input results. With COM- open, the velocity command is considered zero.</li> <li>This input can be made disabled using Pr06.</li> <li>Default: Contact is set. With COM- open, the velocity command is considered zero.</li> </ul> <table border="1" style="width: 100%; border-collapse: collapse; margin-top: 5px;"> <thead> <tr> <th style="width: 15%;">Pr06 value</th> <th style="width: 85%;">Meaning</th> </tr> </thead> <tbody> <tr> <td>0</td> <td>ZEROSPD is disabled.</td> </tr> <tr> <td>1 <small>[Default]</small></td> <td>ZEROSPD is enabled</td> </tr> </tbody> </table>	Pr06 value	Meaning	0	ZEROSPD is disabled.	1 <small>[Default]</small>	ZEROSPD is enabled																			
Pr06 value	Meaning																									
0	ZEROSPD is disabled.																									
1 <small>[Default]</small>	ZEROSPD is enabled																									

# System configuration and wiring

Signal	Pin No.	Symbol	Function	I/F circuit
CW overtravel inhibit	7	CWL	<ul style="list-style-type: none"> <li>If COM- is opened when the movable part of the machine has moved to CW exceeding the limit, the motor does not generate torque.</li> </ul>	<div style="border: 1px solid black; padding: 2px;">SI</div> page 33
CCW overtravel inhibit	8	CCWL	<ul style="list-style-type: none"> <li>If the COM- is opened when the movable part of the machine has moved CCW exceeding the limit, the motor does not generate torque.</li> <li>When Pr04 (Overtravel Limit Input Disabled) = 1, CWL and CCWL inputs are disabled. The default is "Disabled" (1).</li> <li>The dynamic brake can be made operable during CWL/CCWL inputs valid. Use Pr66 (Dynamic Brake Inactivation at Overtravel Limit) to make the dynamic brake operable. The default is to allow the dynamic brake to operate. (Pr66 value is 0.)</li> </ul>	<div style="border: 1px solid black; padding: 2px;">SI</div> page 33

## Input Signals (Position Control) and their Functions

Signal	Pin No.	Symbol	Function	I/F circuit
Command pulse	2 2	PULS1	<ul style="list-style-type: none"> <li>This is the input terminal for command pulses. The maximum allowable input frequency is 500 kpps for line amplifier input and 200 kpps for open collector input. The amplifier is the high-speed photocoupler of TOSHIBA TLP554 or equivalent.</li> </ul>	<div style="border: 1px solid black; padding: 2px;">PI</div> page 33
	2 3	PULS2		
Command sign	2 4	SIGN1	<ul style="list-style-type: none"> <li>The input impedance of PULSE and SIGN signals is 220Ω.</li> <li>Command pulses can be input in three different ways. Use Pr42 to select one of the following. (See App.26.)</li> </ul> <ol style="list-style-type: none"> <li>1) Quadrature (A and B) input</li> <li>2) CW (PULSE)/CCW (SIGN) pulse input</li> <li>3) Command pulse (PULS)/Sign (SIGN) input</li> </ol>	
	2 5	SIGN2		

## Output Signals (Common) and their Functions

Signal	Pin No.	Symbol	Function	I/F circuit
Servo alarm	9	ALM	<ul style="list-style-type: none"> <li>This output (transistor) turns off, when the detector detects an alarm.</li> </ul>	SO 1 page 34
In-position/ At-speed	1 0	COIN	<ul style="list-style-type: none"> <li>The function differs depending on the control mode.</li> </ul>	SO 1 page 34
		Position control	<ul style="list-style-type: none"> <li>In-position output</li> <li>Output(transistor) turns ON when the position error is below the preset value by Pr60 (In-Position Range).</li> </ul>	
		Internal velocity control	<ul style="list-style-type: none"> <li>At-speed.</li> <li>This output (transistor) turns ON, when the motor speed exceeds the preset value by Pr62 (At-Speed).</li> </ul>	
Mechanical brake release	1 1	BRK-OFF	<ul style="list-style-type: none"> <li>Used to release the motor electromagnetic brake.</li> <li>Use "Output (transistor) ON" to release the electromagnetic brake.</li> <li>See Timing Charts (App. 10 -13).</li> </ul>	SO 1 page 34
Warning	1 2	WARN	<ul style="list-style-type: none"> <li>Signal which is selected at Pr09 (warning output selection) will be turned on. This output (transistor) turns ON at least for one second after warning indication signals are output.</li> </ul>	SO 1 page 34
		Pr0A value	Function	
		0	"In-torque limiting" output Output(transistor) turns ON during the In-torque limiting.	
		1	Zero speed output Output(transistor) turns ON when the motor speed becomes lower than that of the preset speed with Pr61(Zero speed).	
		2 [Default]	Output of both over-regeneration and overload warnings Output(transistor) turns ON when either one of over-regeneration or overload is activated.	
		3	Over-regeneration warning output Output(transistor) turns ON when the over-regeneration (more than 85% of permissible power of the internal regenerative discharge resistor) warning is activated.	
		4	Overload warning output Output(transistor) turns ON when the overload (the effective torque is more than 85% of the overload trip level) warning is activated.	
5	Does not function, although displayed.			

# System configuration and wiring

Signal	Pin No.	Symbol	Function	I/F circuit
A-phase output	1 5	OA +	<ul style="list-style-type: none"> <li>Provides differential outputs of the encoder signals (A, B and Z phases) that come from the divider (equivalent to RS422 signals).</li> <li>The logical relation between A and B phases can be selected by Pr45 (Output Pulse Logic Inversion).</li> <li>Not insulated</li> </ul>	<div style="border: 1px solid black; padding: 2px;">PO 1</div> page 34
	1 6	OA -		
B-phase output	1 7	OB +		
	1 8	OB -		
Z-phase output	1 9	OZ +	<ul style="list-style-type: none"> <li>Not insulated</li> </ul>	<div style="border: 1px solid black; padding: 2px;">PO 2</div> page 35
	2 0	OZ -		
Z-phase output	2 1	CZ	<ul style="list-style-type: none"> <li>Z-phase signal output in an open collector</li> <li>Not insulated</li> </ul>	<div style="border: 1px solid black; padding: 2px;">PO 2</div> page 35
Signal ground	1 4	GND	<ul style="list-style-type: none"> <li>Signal ground for pulse output</li> <li>Internally isolated from the control power (COM-).</li> </ul>	-----

## Others

Signal	Pin No.	Symbol	Function	I/F circuit
Frame ground	2 6	FG	<ul style="list-style-type: none"> <li>Internally connected to the earth terminal.</li> </ul>	-----

## Output Signals (Others) and their Functions

Signal	Pin No.	Symbol	Function	I/F circuit
Speed monitor signal output	1	SP	<ul style="list-style-type: none"> <li>Outputs the motor speed, or voltage in proportion to the commanded speed with polarity.               <ul style="list-style-type: none"> <li>+ : CCW rotation</li> <li>- : CW rotation</li> </ul> </li> <li>Use Pr07 (Velocity Monitor Selection) to switch between actual and commanded speed, and to define the relation between speed and output voltage.</li> </ul>	<div style="border: 1px solid black; padding: 2px;">AO</div> page 35
Torque monitor output	2	IM	<ul style="list-style-type: none"> <li>Outputs the output torque, or voltage in proportion to the position error with polarity.               <ul style="list-style-type: none"> <li>+ : generating CCW-torque</li> <li>- : Fgenerating CW-torque</li> </ul> </li> <li>Use Pr08 (Torque Monitor Selection) to switch between torque and positional error, and to define the relation between torque/positional error and output voltage.</li> </ul>	<div style="border: 1px solid black; padding: 2px;">AO</div> page 35
Signal ground	3	GND	<ul style="list-style-type: none"> <li>Signal ground for monitor signal</li> <li>Internally isolated from the control power (COM-).</li> </ul>	-----

# CN I/F Connector

## Interface Circuit (Input Circuit)

### SI Connecting to sequence input signals

- Connect to a contact of switch and relay, or a transistor of an open collector output.
- Use a switch or relay for micro current so that insufficient contact can be avoided.
- Can be used with COM- instead of COM+

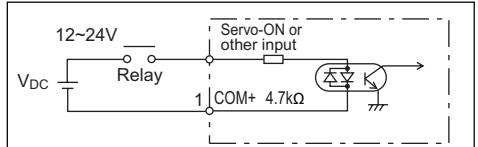
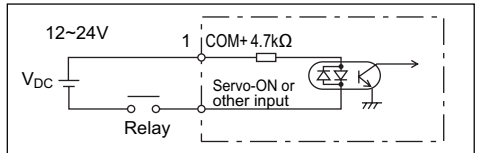

Available at reverse polarity

### PI Command pulse input circuit

#### 1) Line Amplifier I/F

- This is a good signal transmission method that is less sensitive to noises. We recommend you to use this to maintain the reliability of signals.

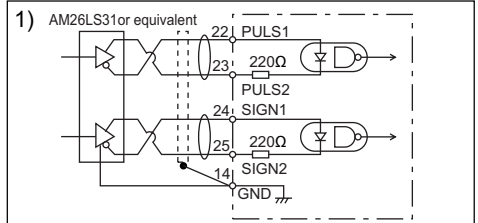

#### 2) Open Collector I/F

- This uses an external control power supply(VDC).
- This requires a current-limiting resistor corresponding to the capacity of the VDC value.

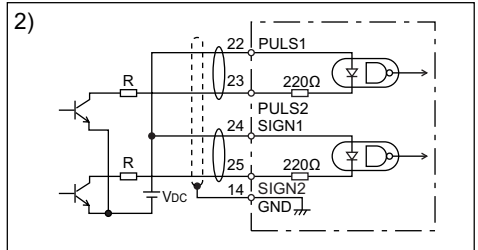

V <sub>DC</sub>	R value
12V	1kΩ/4W
24V	2kΩ/4W

$$\frac{V_{DC} - 1.5}{R + 220} \cong 10\text{mA}$$

 shows a pair of twisted wires.

# System configuration and wiring

## Interface Circuit (Output Circuit)

### SO1 Sequence output circuit

- This comprises a Darlington amplifier with an open collector. This is connected to a relay or photo coupler.
- There exists a collector-to-emitter voltage  $V_{CE(SAT)}$  of approx. 1.2V at transistor ON, because of Darlington connection of the output transistor. Note that normal TTL IC can't be directly connected since this does not meet  $V_{IL}$  requirement.
- If the recommended current value of the actual photocoupler is 10mA, calculate the resistance using the formula below.

$$R = \frac{V_{DC} - 2.5}{10} \quad [K\Omega]$$

For the recommended current value, see the data sheets of actual equipment and photocoupler.

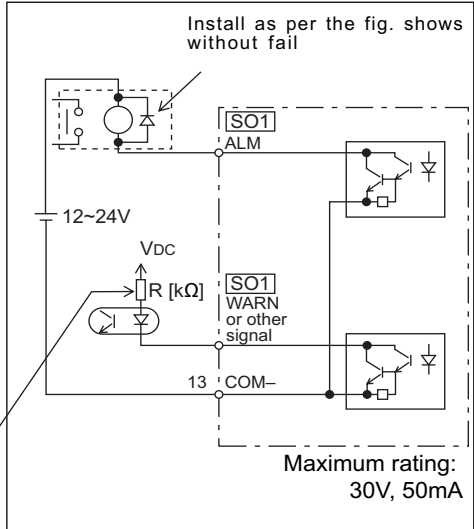

### PO1 Line Driver (Differential Output) Output

- Provides differential outputs of encoder signals (A, B and Z phases) that come from the scaler.
- Receive these signals with a line receivers. In this case, install a resistor of approx. 330Ω between the inputs.

 shows a pair of twisted wires.

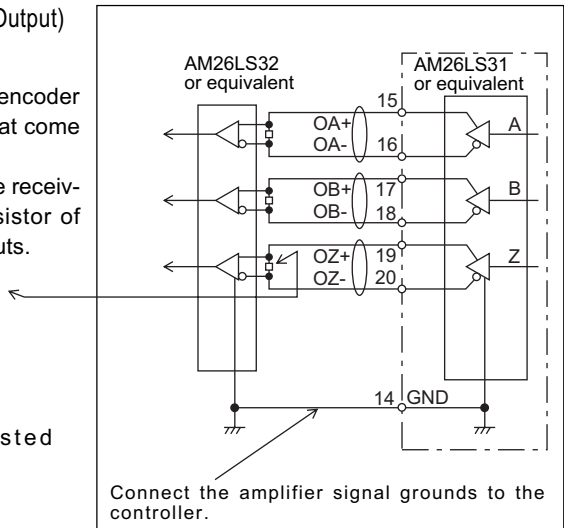

## PO2 Open Collector Output

- Outputs Z-phase signals among those from the encoder. The outputs are non-insulated.
- Receive these signal with high-speed photo coupler at controller side, since these Z-phase signal width is normally narrow.

 shows a pair of twisted wires.

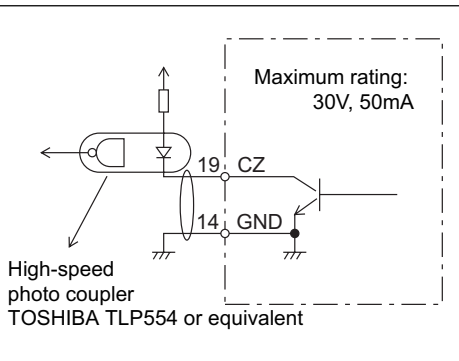

## CN MON Connector

### Monitor Circuit (Output Circuit)

#### AO Analogue Monitor Output

- Output from CN MON Connector
- This output is the velocity monitor signal (SP) or torque monitor signal (IM).
- The signal range is approx. 0 to 9V.
- The output impedance is 1k $\Omega$ . Pay attention to the input impedance of your measuring instruments and external circuits connected.

<Resolution>

- 1) Velocity monitor signal (SP): 8r/min./LSB calculated from 6V/3000r/min (Pr07 = 3)
- 2) Torque monitor signal (IM): 0.4%/LSB calculated from 3V/rated value (100%)

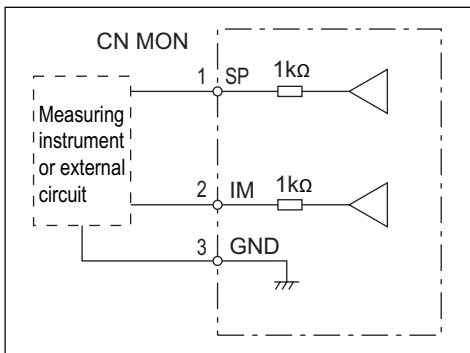

# Parameter Setting

## Overview

The servo amplifier has various parameters that are used for adjusting or setting the features or functions of the amplifier. This section describes the purpose and functions of these parameters. Understanding these parameters is essential for obtaining the best, application-specific operation of the amplifier.

You can view, set and adjust these parameters using your personal computer with the communication software PANATERM<sup>®</sup>.

## Parameter Groups and Listing

Group	ParameterNo. Pr**	Brief explanation
Function selection	00 ~ 0F	You can select the control mode, allocate I/O signals, and set the baud rate and etc.
Adjustment	10 ~ 1F	You can set various factors and constants such as the servo gains (1st and 2nd) for position, velocity and integration, and time constants of filters.
	20 ~ 22	Real time auto-tuning parameters. You can set the real time auto-tuning mode, select the machine stiffness, etc.
Position control	30 ~ 35	You can set the parameters relating to the switching between 1st and 2nd gains.
	40 ~ 4D	You can set the input format of command pulses, logical selection, encoder pulse rate and pulse scaler.
Internal velocity and torque control	53 ~ 5A	You can set the internal speed (1st to 4th), and its acceleration and deceleration time.
Sequence	5E	You can set the torque limit.
	60 ~ 6C	You can set the conditions for detecting the output such as in-position and zero-speed, and set the processing conditions at excess position error, etc.  You can also set the conditions for stopping at the main power-off, in-alarm and servo-off, or conditions for the error counter clearance, etc.

For details, see "Details of Parameters" in Appendix.

### <Notes>

Parameters marked with \* are enabled, when set data are written to EEPROM, main power is once turned OFF and then turned ON again.

## Parameters for Selecting Function

ParameterNO. (Pr**)	Parameter description	Range	Default	Unit
0 0	Axis address	0 ~ 15	1	-----
0 1	(Internal use)	-----	0	-----
0 2	Control mode set-up	0 ~ 1	0	-----
0 3	(Internal use)	-----	1	-----
0 4	Overtravel Input inhibit	0 ~ 1	1	-----
0 5	(Internal use)	-----	1	-----
0 6	ZEROSPD input selection	0 ~ 1	1	-----
0 7	Speed monitor(SP) selection	0 ~ 9	3	-----
0 8	Torque monitor (IM) selection	0 ~ 5	0	-----
0 9	Warning output selection	0 ~ 5	2	-----
0 A	(Internal use)	-----	1	-----
0 B	(Internal use)	-----	1	-----
0 C	Baud rate set-up of RS232C	0 ~ 2	2	-----
0 D	(Internal use)	-----	2	-----
0 E, 0 F	(Internal use)	-----	0	-----

For values marked with \*, see page 36.

## Parameters for Adjusting Time Constants of Gain Filters, etc.

ParameterNO. (Pr**)	Parameter description	Range	Default	Unit
1 0	1st position loop gain	0 ~ 2000	1 0 0	1 / s
1 1	1st velocity loop gain	1 ~ 3500	1 0 0	Hz
1 2	1st velocity loop integration time constant	1 ~ 1000	5 0	ms
1 3	1st speed detection filter	0 ~ 5	4	-----
1 4	1st torque filter time constant	0 ~ 2500	5 0	0.01ms
1 5	Velocity feed forward	0 ~ 100	0	%
1 6	Feed forward filter time constant	0 ~ 6400	0	0.01ms
1 7	(Internal use)	-----	0	-----
1 8	2nd position loop gain	0 ~ 2000	1 0 0	1/s
1 9	2nd velocity loop gain	1 ~ 3500	1 0 0	Hz
1 A	2nd velocity loop integration time constant	1 ~ 1000	5 0	ms
1 B	2nd speed detection filter	0 ~ 5	4	-----
1 C	2nd torque filter time constant	0 ~ 2500	5 0	0.01ms
1 D	Notch frequency	100 ~ 1500	1 5 0 0	Hz
1 E	Notch width selection	0 ~ 4	2	-----
1 F	Disturbance torque observer	0 ~ 8	8	-----

# Parameter Setting

## Parameters for Defining the Real Time Auto Gain Tuning

Parameter No. (Pr**)	Parameter description	Range	Default	Unit
2 0	Inertia ratio	0 ~ 10000	1 0 0	%
2 1	Real time auto tuning set-up	0 ~ 3	0	-----
2 2	Machine stiffness at auto tuning	0 ~ 9	2	-----
2 3	(Not available)	-----	1 0 0	-----
24~2F	(Internal use)	-----	0	-----

## Parameters for Adjustments (for 2nd Gain)

Parameter No. (Pr**)	Parameter description	Range	Default	Unit
3 0	2nd gain action set-up	0 ~ 1	0	-----
3 1	Position control switching mode	0 ~ 8	0	-----
3 2	Position control switching delay time	0 ~ 10000	0	166 $\mu$ s
3 3	Position control switching level	0 ~ 10000	0	-----
3 4	Position control switching hysteresis	0 ~ 10000	0	-----
3 5	Position loop gain switching time	0 ~ 10000	0	(1 + Setting value) x166 $\mu$ s
3 6	(Not available)	-----	0	-----
37~39	(Not available)	-----	0	-----
3E~3F	(Internal use)	-----	0	-----

## Parameters for Position Control

Parameter No. (Pr**)	Parameter description	Range	Default	Unit
*4 0	Command pulse multiplier set-up	1 ~ 4	4	----
*4 1	Command pulse logic inversion	0 ~ 3	0	----
*4 2	Command pulse input mode set-up	0 ~ 3	1	----
4 3	(Internal use)	1	1	----
*4 4	Output pulses per single turn	1 ~ 16384	2 5 0 0	----
*4 5	Pulse output logic inversion	0 ~ 1	0	----
4 6	Numerator of 1st command pulse ratio	1 ~ 10000	1 0 0 0 0	----
4 7	Numerator of 2nd command pulse ratio	1 ~ 10000	1 0 0 0 0	----
4 8	(Internal use)	----	1 0 0 0 0	----
4 9	(Internal use)	----	1 0 0 0 0	----
4 A	Multiplier of numerator of command pulse ratio	0 ~ 17	0	2 <sup>n</sup>
4 B	Denominator of command pulse ratio	1 ~ 10000	1 0 0 0 0	----
4 C	Smoothing filter set-up	0 ~ 7	1	----
4 D	Counter clear input	0 ~ 1	0	----
4 E, 4 F	(Internal use)	----	0	----

For values marked with \*, see <Note> in page 36.

## Parameters for Velocity and Torque Control

Parameter No. (Pr**)	Parameter description	Range	Default	Unit
5 0	(Internal use)	----	5 0 0	----
5 1	(Internal use)	----	1	----
5 2	(Internal use)	----	0	----
5 3	1st internal speed	- 10000 ~ 10000	0	r/min
5 4	2nd internal speed	- 10000 ~ 10000	0	r/min
5 5	3rd internal speed	- 10000 ~ 10000	0	r/min
5 6	4th internal speed	- 10000 ~ 0000	0	r/min
5 7	(Internal use)	----	3 0 0	----
5 8	Acceleration time set-up	0 ~ 5000	0	2ms/kr/min
5 9	Deceleration time set-up	0 ~ 5000	0	2ms/kr/min
5 A	S-shaped Accel./Decel. time set-up	0 ~ 500	0	2ms
5 B	(Internal use)	----	0	----
5 C	(Internal use)	----	3 0	----
5 D	(Internal use)	----	0	----
5 E	Torque limit set-up	0 ~ 500	3 0 0	%
5 F	(Internal use)	----	0	----

# Setting the Parameters

## Parameters for Sequence

Parameter No (Pr )	Parameter description	Range	Default	Unit
6 0	In-position range	0 ~ 32767	1 0	Pulse
6 1	Zero speed	0 ~ 10000	5 0	r/min
6 2	At-speed	0 ~ 10000	1 0 0 0	r/min
6 3	Position error set-up	0 ~ 32767	1875	256Pulse
6 4	Position error invalidation	0 ~ 1	0	-----
6 5	(Internal use)	-----	1	-----
6 6	Dynamic Brake inhibition at overtravel limit	0 ~ 1	0	-----
6 7	(Internal use)	-----	0	-----
6 8	Sequence at alarm	0 ~ 3	0	-----
6 9	Sequence at Servo-OFF	0 ~ 7	0	-----
6 A	Mech. break action set-up at motor stadstill	0 ~ 100	0	2ms
6 B	Mech. break action set-up at motor in motion	0 ~ 100	0	2ms
* 6 C	External regenerative discharge resistor selection	0 ~ 2	2	-----
6D ~ F	(Internal use)	-----	0	-----

For values marked with \*, see <Note> in page 36.

Set-up range of excessive positional deviation of Pr63 is "Set-up value x 256 pulses".  
Set-up is made before shipment so that the excessive positional deviation error takes place at value in excess of 1875 x 256 pulses.

### Pr5E Torque limit set-up

Power supply for amplifier	Amplifier	Amplifier type	Default
Single-phase 100V	MUDS3A1A1A	Type 1	3 0 0
	MUDS5A1A1A		
	MUDS011A1A	Type 2	
	MUDS021A1A		
Single-phase 200V	MUDS041A1A	Type 3	3 5 0
	MUDS022A1A	Type 2	3 3 0
MUDS042A1A	Type 3		
3-phase / Single-phase 200V	MUDS3A5A1A	Type 1	3 0 0
	MUDS5A5A1A		
	MUDS015A1A		
3-phase 200V	MUDS023A1A	Type 2	3 3 0
	MUDS043A1A		
	MUDS083A1A	Type 3	3 0 0

- Pr5E "Torque limit set-up" disables set-up in excess of the values set up for the system parameter "Max. torque set-up".  
Values for "Max. torque set-up" are same as defaults.
- The system parameters are fault parameters that cannot be changed with PANATERM<sup>®</sup> or on the operation panel.

## Setting the Parameters

- You can set the Parameters with your personal computer with the S-series communication software PANATERM<sup>®</sup>.

### <Notes>

For the use of PANATERM<sup>®</sup> for parameter handling, see the instruction manual of the software.

## Overview of PANATERM<sup>®</sup>

You can conduct the following operations using PANATERM<sup>®</sup>:

- 1) Setting the Parameters for amplifier, storing them, and writing in the memory (EEPROM)
- 2) Monitoring input/output status, monitoring pulse input, monitoring load ratio.
- 3) Checking current error status and error history
- 4) Measurement of wave form graphic data, and storage and reading of the data
- 5) Automatic tuning
- 6) Measurement of frequency characteristics

## How to Connect

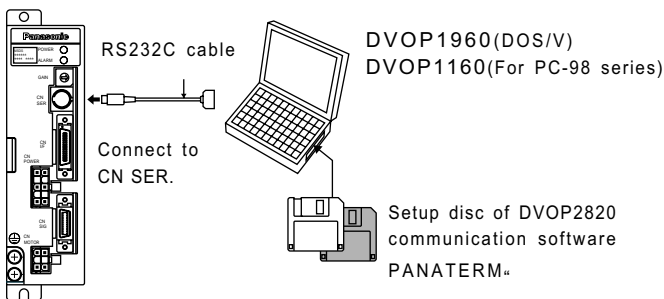

# Setting the Parameters

## Installing PANATERM® on a hard disc

<Notes>

1. The memory capacity of the hard disc should be 15MB or more. Prepare OS of Windows®95 or Windows®98.
2. Install PANATERM® with setup discs, otherwise the software does not work.

## Procedure

- 1) Turn on your personal computer. Start Windows®95 (or 98).  
(If there is any application program on, close all of them.)
- 2) Insert the PANATERM® setup floppy disk in the floppy disk drive.
- 3) Start Explorer, and switch (select) to the floppy disk drive. (For the procedure for starting the Explorer program, see the instructions for Windows®.)
- 4) Double click on the setup program (Setup. exe) in the floppy disk. (PANATERM® setup program will start.)
- 5) Click on  to start the setup program.
- 6) Keep the operation according to the guide of the setup program.  
(When indication to replace the setup disk appears, follow this instruction.)
- 7) Click on  to start the setup routine.
- 8) Confirm an message "Setup completed". Then click on .
- 9) Close all the applications. Then restart Windows®. PANATERM® will be added to the program menu when restarted.

## Starting PANATERM®

<Notes>

1. Once you install PANATERM® on your hard disc, you do not have to install it again for next use.
2. Before using PANATERM®, the amplifier, power supply, motor and encoder should be connected. For the procedure for starting PANATERM®, see the Windows® manual.

## Procedure

- 1) Turn on your personal computer. Start Windows®95 (or 98).
- 2) Turn on the amplifier.
- 3) Click on the start button of Windows® (see the Windows® manual).
- 4) Select (click on) PANATERM® from the program menu.
- 5) An opening splash will be displayed for two seconds, and then PANATERM® screen will appear.

For the operation, functions and other details about PANATERM®, see the Instructions for the PANATERM® program.

# Trial Run

## Inspections before Trial Run

### 1) Inspecting the wiring

- Make sure that all wire connections (especially main power and motor output ) are correct.
- Make sure that there is no short, and earth wires are properly connected.
- Make sure that there is no poor connections.

### 2) Inspecting the power specifications

- Make sure that the voltage is correct.

### 3) Securing the servo motor

- Make sure that the servo motor is firmly secured.

### 4) Disconnecting the motor load

Trial run without load

### 5) Releasing the brake

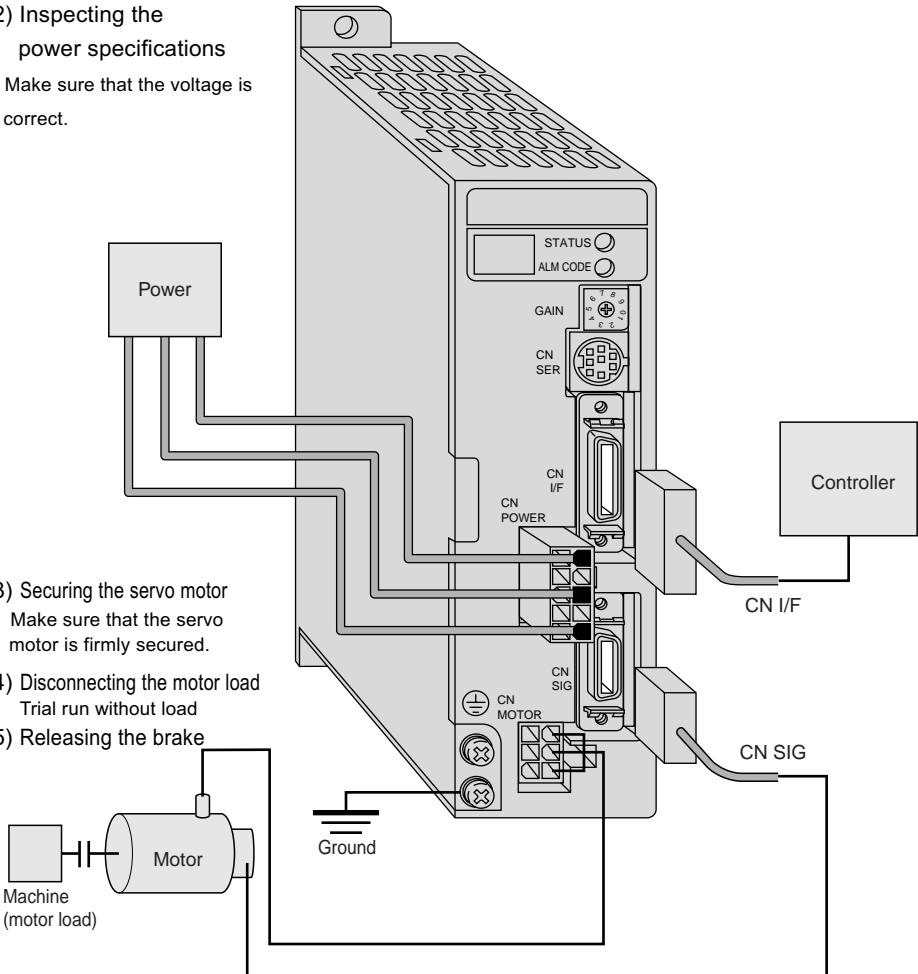

## Operation with CN I/F Connected

- 1) Connect CN I/F.
- 2) Connect the control signal (COM+/-) to the power supply (12 to 24V DC).
- 3) Turn the main power (amplifier) ON.
- 4) Check the defaults of the parameters. Control mode setting (Pr2 value: 0).
- 5) Connect between SRV-ON (CN I/F pin 2) and COM- (CN I/F pin 13) to make Servo-On active. The motor will be kept excited.

### Run at Position Control Mode

- 1) Set Pr42 (Command Pulse Input Mode Set-Up) according to the output form of the controller. Then write it down to EEPROM. Then turn the power OFF and then ON again.
- 2) Send a low-frequency pulse signal from the controller to the amplifier to run the motor at low speed.
- 3) Check the motor speed at monitor mode with PANATERM<sup>®</sup>.
  - Make sure that the speed is per the set-up.
  - Check if the motor stops when the command (pulse) is stopped.

### Wiring Diagram

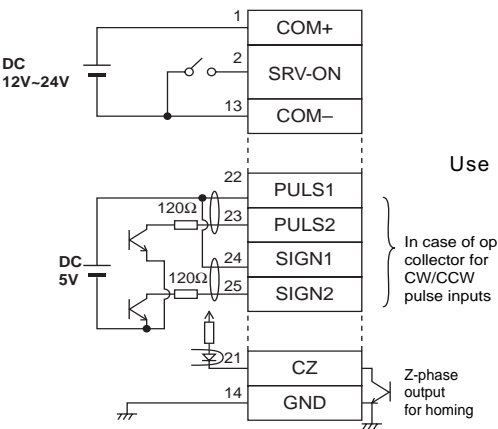

### Parameters

PrNo.	Parameter description	Value
Pr02	Control mode set-up	0
Pr04	Overtravel input inhibit	1
Pr42	Command pulse input mode set-up	1

Use the controller to send command pulses.

### Input Signals Status

No.	Input signal	Monitor display	with PANATERM <sup>®</sup>
0	Servo-ON	+ A	
A	Counter clear	---	

# Trial Run

## Set-up of motor speed and input pulse frequency

Input pulse frequency (pps)	Motor speed (r/min)	$\frac{\text{Pr 46} \times 2^{\text{Pr 4A}}}{\text{Pr 4B}}$
		2500 P / r
500k	3000	$\frac{10000 \times 2^0}{10000}$
250 k	3000	$\frac{10000 \times 2^0}{5000}$
100 k	3000	$\frac{10000 \times 2^0}{2000}$
500 k	1500	$\frac{5000 \times 2^0}{10000}$

\* You can set any value by setting any value for the numerator and denominator. However, the motor action will not follow the extreme setting of the ratio. It is recommended to set within a range from 1/50 to 20.

## Relationship between motor speed and input pulse frequency

(Example) Rotate the motor by 60 degrees with an overall reduction ratio of 18/365

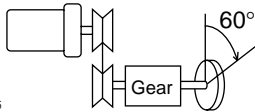

Pulley ratio: 18/60

Gear ratio: 12/73

Overall reduction: 18/365

	Encoder pulse
	2500 P / r
$\frac{\text{Pr 46} \times 2^{\text{Pr 4A}}}{\text{Pr 4B}}$	$\frac{365 \times 2^0}{108}$
Theory	Set the parameter so that motor turns 60° with 10000 pulses when a command is entered from the controller to the amplifier.
Determining the parameter	$\frac{365}{18} \times \frac{10000}{10000} \times \frac{60^\circ}{360^\circ}$ $= \frac{365 \times 2^0}{108}$

### <Notes>

Default: The motor output shaft turns one revolution with 10000 pulses.

### Test Run at Internal Velocity Control Mode

- 1) Select the internal velocity control mode (Pr02: 1) for the control mode.
- 2) Run with zero speed clamp input (ZEROSPD) (5 pin) switch close, and rotate the motor with the combination of the internal command speed selection INTSPD 1 (6 pin) and INTSPD 2 (4 pin).
- 3) Check the motor speed on the PANATERM<sup>®</sup> monitor.  
     Æ Speed and direction
- 4) Make sure that the motor stops by making zero speed clamp input (ZEROSPD) open.
- 5) To change the speed or direction, adjust the following parameters again.  
     Pr53 - Pr56: Velocity set-up for 1st speed through 4th speed See "Details of Parameters" in Appendix 31.

### Wiring Diagram

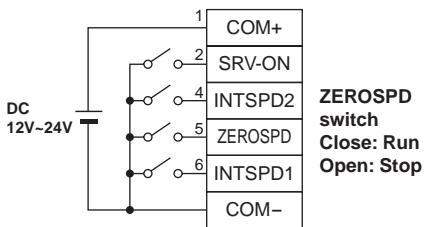

### Parameters

PrNo.	Parameter description	Value	Default
Pr02	Control mode set-up	1	0
Pr04	Overtravel input inhibit	1	1
Pr06	ZEROSPD input selection	1	1
Pr53 ~ Pr56	Velocity set-up for 1st speed through 4th speed	Set as required	0
Pr58	Acceleration time set-up		0
Pr59	Deceleration time set-up		0
Pr5A	S-shaped accel/dec time set-up		0

Internal speed	DIV/INTSPD1 (6 pin)	CL/INTSPD2 (4 pin)
1st speed (Pr53)	OPEN	OPEN
2nd speed (Pr54)	CLOSE	OPEN
3rd speed (Pr55)	OPEN	CLOSE
4th speed (Pr56)	CLOSE	CLOSE

### Input Signal Status

No.	Input signal	Monitor display	
0	Servo-ON	+ A	
5	Speed zero clamp	----	Stop with +A

# Trial Run

## Fundamental Operations and LED Indications

**1. Turn on the power.**

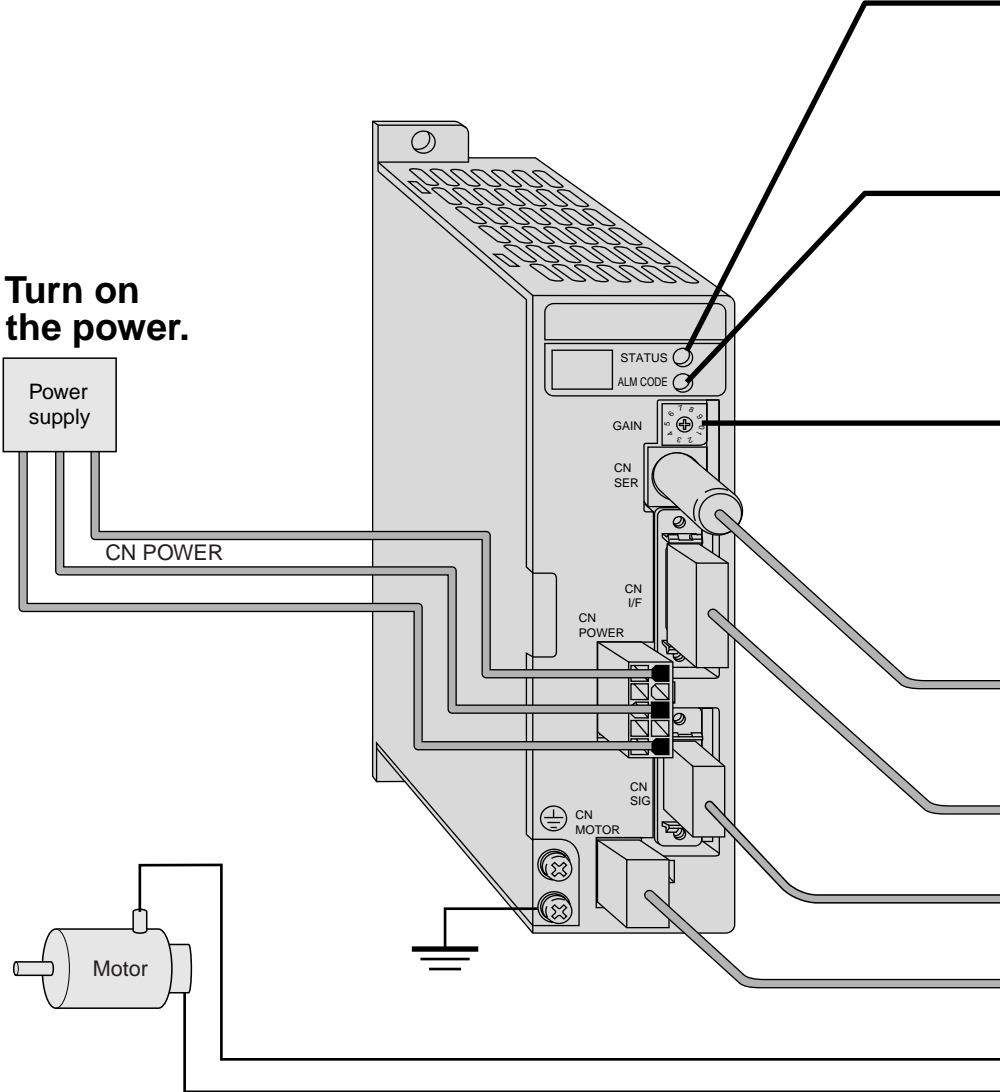

## 2. Check LED status.

LED color	Meaning
○ Green	Main power is on. Amplifier power is on.
◐ Orange	Flashing when warning occurs. (Overload, excessive regenerative energy)
● Red	Alarm

Make sure that the alarm code LED is not flashing.  
(Under the normal operation, the alarm indicator is OFF.)

This indicator will start flashing when an alarm occurs.  
Alarm codes (see page 60-65) are indicated by the number of flash  
(in orange and red)  
Orange: Tens digits, Red: Unit digits

Set the rotary switch to default "0" position for GAIN adjustment.

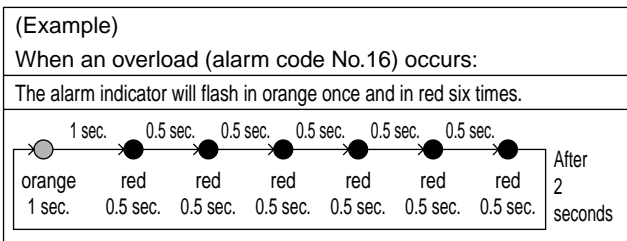
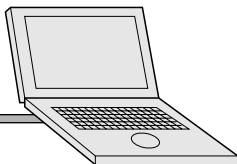

## 3. Set Parameters.

Prepare a personal computer and PANATERM®.

CN I/F

CN SIG

CN MOTOR

## 4. Input commands relevant to the desirable control mode.

# Adjustments

## Purposes of Gain Adjustment

In case of the servo motor, the motor is required to act per any command without any time delay, or without missing any commands. To ensure this, gain adjustment is necessary.

<Example: ball screw>

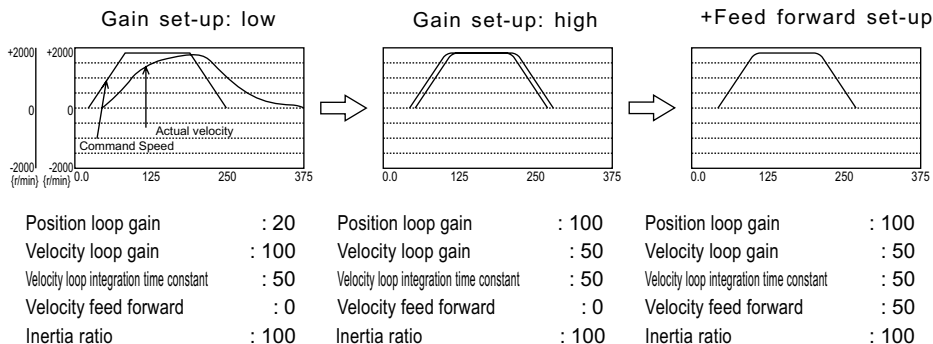

## Types of Gain Adjustment

Type		Description	Gain set value of rotary switch for gain adjustment
Auto-automatic adjustment	Normal mode auto gain tuning	Accelerate and decelerate the motor per the preset (internally fixed) patterns to calculate the load inertia from the required torque. Then automatically define appropriate gains according to the inertia.	0
	Real time auto gain tuning	During an actual operation, calculate the load inertia in real time. Then automatically define appropriate gains according to the inertia. The gains will be automatically adjusted against the fluctuation of load inertia during operation.	
Manual adjustment	Manual gain tuning	You can manually adjust the necessary gains to obtain the most appropriate action by monitoring command to the amplifier, motor speed, torque and position error as the monitor signals (SP, IM), or using the optional communication software, PANATERM. (especially with its graphic function).	1 - 9
	Gain tuning using the rotary switch for gain adjustment	Gain adjustment is available by digital setting with the rotary switch.	

## Applicability of Automatic Adjustment

Item	Conditions
Load inertia	<ul style="list-style-type: none"> <li>• Must be at least three times as large as the motor inertia, but not greater than 20 times.</li> <li>• Must not fluctuate much</li> </ul>
Load	<ul style="list-style-type: none"> <li>• The machine (motor load) and its coupling must have a higher mechanical stiffness.</li> <li>• The backlash of the gears and other equipment must be small.</li> <li>• Eccentric load must be smaller than one-fourth of the rated torque.</li> <li>• The viscous load torque must be smaller than one-fourth of the rated torque.</li> <li>• Any oscillation must not cause any mechanical damages of the machine (motor load).</li> <li>• Two CCW turns and subsequent two CW turns must in no case cause any troubles.</li> </ul>

The auto gain tuning affects the values of the following six parameters.

Pr10	1st Position Loop Gain	Pr13	1st Speed Detection Filter
Pr11	1st Velocity Loop Gain	Pr14	1st Torque Filter Time Constant
Pr12	1st Velocity Loop Integration Time Constant	Pr20	Inertia Ratio

- Pr15 (Velocity Feed Forward) will be automatically changed to 0%, if the auto gain tuning is executed.

### <Notes>

The real time auto gain tuning will be disabled in the following cases:

- 1) Running pattern at a constant speed
- 2) Running pattern with a small acceleration/deceleration

## Relationship between Gain Adjustment and Mechanical Stiffness

To increase the mechanical stiffness,

- 1) The machine (motor load) should be firmly secured to a rigid foundation.
- 2) The coupling between the motor and machine should be a high-stiffness special one designed for servo motors.
- 3) The timing belt should have a larger width. The tension of the timing belt should be adjusted according to the allowable axial load of the motor.
- 4) The gears should have a smaller backlash characteristic.
  - The inherent frequency (resonance) of the machine significantly affects the gain adjustment of the servo motor. If the machine has a lower resonance frequency (i.e. lower stiffness), you can't set the high response of the servo system.

# Adjustments

## How to Adjust Gain

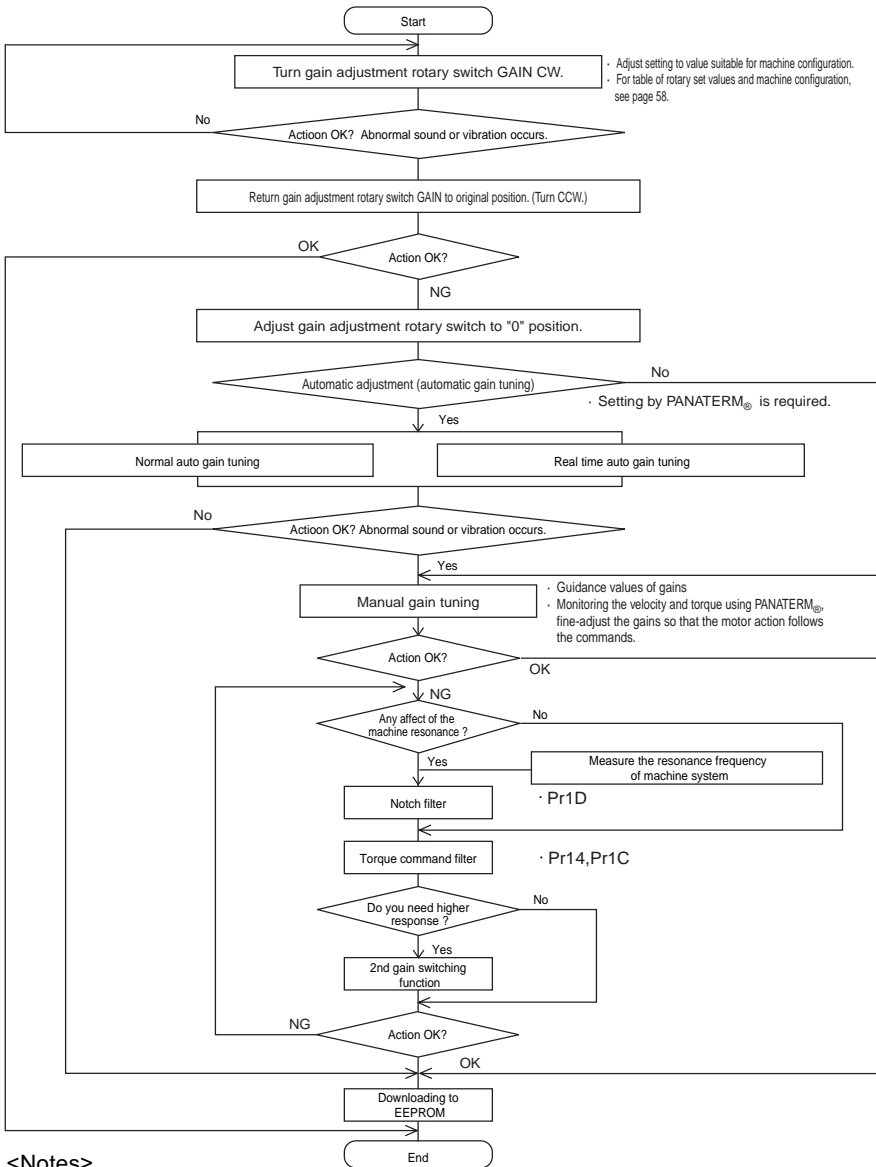

### <Notes>

- Pay extra attention to the safety.
- If the machine enters to oscillation (abnormal sound and vibration), shut off the power immediately, or change to Servo-OFF.

# How to Use "Normal Auto-Gain" Tuning

Automatic tuning is available when the gain adjustment rotary switch GAIN is set to "0" position only.

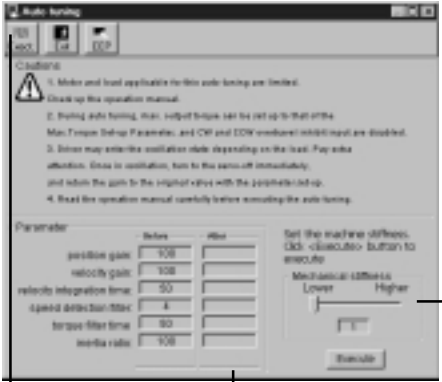

- 1) Start PANATERM®, and click on "Auto tuning" in the window menu to open the automatic tuning screen.
- 2) Move the bar for mechanical stiffness to set the stiffness. To start from smaller value (1).

Driving method	Mechanical stiffness
Ball screw + direct coupling	4 Å ` 8
Ball screw + timing belt	3 Å ` 6
Timing belt	2 Å ` 5
Gear, or rack & pinion	1 Å ` 3
Others: lower stiffness	1 Å ` 3

- 3) Click on [Start] button to execute automatic tuning.

- CN I/F pin 2: Servo-ON
- Pr ID (Notch Frequency) = 1500

- 4) 15 seconds, the motor repeats the cycle 5 times (at most), which consists of two CCW revolutions and two CW revolutions. Note that this process doesn't necessarily repeat 5 cycles and this is not abnormal. Value is entered in the post-application column after tuning.

- 5) Download the obtained gain values to EEPROM. Note that if you turn off the power before downloading, the gain values will be lost.

<Notes>

- Never perform normal automatic tuning with single motor nor with single amplifier. Otherwise, Pr20 (inertia ratio) becomes zero, possibly resulting in oscillation.

Symptom	Cause	Remedy
Error message displayed	Either one of Alarm, Servo-Off or Position Error Counter Clear activated.	<ul style="list-style-type: none"> <li>• Avoid operation near the limit switch or home position sensor.</li> <li>• Turn to Servo-ON.</li> <li>• Cancel the Position Error Counter Clear.</li> </ul>
Values of gain affecting parameters (e.g. Pr10) doesn't change.	The load inertia cannot be calculated.	<ul style="list-style-type: none"> <li>• Execute again with Pr10 and Pr11 reduced to 10 and 50 respectively.</li> <li>• Execute the manual adjustment. (Calculate and input load inertia.)</li> </ul>
Motor does not turn.	CL/INTSPD 2 (4 pin) of CN I/F input	Make CL/INTSPD 2 (4 pin) of CN I/F OFF.

# Adjustments

## How to Use "Real Time Auto-Gain" Tuning

Automatic tuning is available when the gain adjustment rotary switch GAIN is set to "0" position only.

- 1) Start PANATERM<sup>®</sup>, and go to Parameter Set-up Mode.
- 2) Set Pr1F (Disturbance torque observer) to 8 (invalid).
- 3) Set Pr22 (Real time auto tuning machine stiffness).

Driving method	Mechanical stiffness
Ball screw + direct coupling	4 ~ 8
Ball screw + timing belt	3 ~ 6
Timing belt	2 ~ 5
Gear, or rack & pinion	1 ~ 3
Others: lower stiffness	1 ~ 3

First, set the parameter to the smallest value and then gradually increase with which no abnormal sound or vibration will occur.

- 4) Set Pr21 (Real time auto tuning mode) to 1 or 2.
  - The operation may not be stable depending on the operation pattern. In this case, set the parameter to 0 (to disable the auto tuning function).

Pr21 value	Real time auto tuning set-up	Fluctuation of load inertia during operation
0	Disabled	-----
1	Enabled	Almost no change
2		Small change
3		Quick change

- With a larger value, the response to the change in load inertia (acceleration) is quicker.

- 5) Start the motor.
- 6) If the fluctuation in load inertia is small, stop the motor (machine), and set Pr21 to 0 to fix the gain (in order to raise the safety).
- 7) FDownload the obtained gain values to EEPROM. Note that if you turn off the power before downloading, the gain values will be lost.

### <Notes>

- Before changing Pr21 or Pr22, stop (servo-lock) the motor.
- Don't modify Pr10 through Pr15.  
Otherwise it may give a shock to the machine.

## How to Adjust Gain Manually

### Before Adjustment

You may adjust the gains by viewing or hearing the motions and sound of the machine during operation. But, to adjust the gains more quickly and precisely, you can obtain quicker and secure adjustment by analog wave form monitoring.

#### 1. Wave form graphic function of PANATERM<sup>®</sup>

You can view the graphic information of the command to the motor, actual motor action (speed, torque and position error) on the computer display screen.

For details, see the instructions of PANATERM<sup>®</sup>.

#### 2. Using the analogue monitor output

You can measure the actual motor speed, commanded speed, torque, position error in analog voltage level with an oscilloscope. To do this, it is necessary to specify the types of output signals and output voltage level by using Pr07 (Velocity monitor selection), Pr08 (Torque monitor selection).

For details, see "CN MON Connector" in the main part of this manual, and "Details of Parameters" in Appendix.

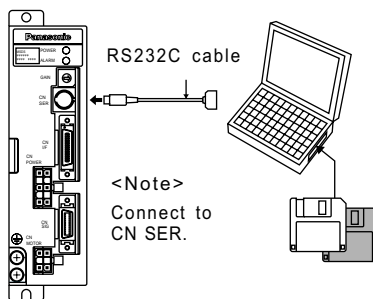

### Guidance Values of Gains, and How to Adjust

See the table below for the guidance values of gains, if the inertia ratio has been set correctly.

Machine	Position loop gain Pr10	Velocity loop gain Pr11	Velocity loop integration time constant Pr12
Ball screw	1 0 0	5 0	5 0
Timing belt	5 0	2 5	5 0
Rack & pinion	5 0	2 5	200 Å ` 500

How to adjust

- 1) Adjust the velocity loop gain Pr11.
- 2) Take "Position loop gain Pr10 set-up value  $\dot{\text{A}}\ddot{\text{O}} 2 \times$  Velocity loop gain Pr11 set-up value" as a guidance value of stable operation.
- 3) Set-up of "Position loop gain Pr10 set-up value  $> 5 \times$  Velocity loop gain Pr11 set-up value" will lead to hunting and oscillation.

<Notes>

Set-up of current loop gain for adjustment by customers is unavailable.

Values are fixed to those set up before shipment by motor model.

# Adjustments

## How to Adjust the Gain at Position Control Mode

- 1) Input the inertia ratio of Pr20. For horizontal axis, take measurements on the basis of "Normal auto tuning". For vertical axis, obtain values through calculations.
- 2) Conduct adjustments with the parameters shown in the following table taken as guidance values.

Parameter No.	Parameter description	Guidance value	Concept of adjustment
Pr 10	1st position loop gain	5 0	OK, if there is no problem with the motion. With a larger value, responsibility improves. With an excessively large value, oscillation occurs. OK, if there is no unusual running noise. If unusual noise is heard, decrease
Pr 11	1st velocity loop gain	3 0	the value. OK, if there is no problem with the motion. With a smaller value,
Pr 12	1st velocity loop integration time constant	5 0	responsibility improves. With an excessively small value, oscillation occurs. With a larger value, deviation pulses may not be converged but left over indefinitely.
Pr 13	1st velocity detection filter	0	OK, if there is no unusual running noise. If vibration is found,
Pr 14	1st torque filter time constant	5 0	change the value. Adjust the value so that "Pr11 set-up value x Pr14 set-up value" may be smaller than 10000. If vibration takes place, make Pr14 larger and Pr11 smaller.

If you want to improve the response further, adjust Pr15 (Velocity Feed Forward) within the extent that the motor (machine) does not generate abnormal sound or vibration.

- With a larger value, overshoot and/or chattering of in-position signals may occur, which results in a longer in-position time. Note that this may be improved by adjusting the value of Pr16 (Feed Forward Filter).

## How to Adjust the Gains at Internal Velocity Control mode

- 1) Start the motor (machine).
  - 2) Increase the value of Pr11 (1st Velocity Loop Gain) gradually until the motor (machine) does not generate abnormal sound or vibration.
  - 3) Decrease the value of Pr12 (1st velocity Loop Integration Time Constant) according to the delay of commands.
- With a smaller value, overshoot may occur.

## How to improve the response further

You can manually adjust the 2nd gain.

With the 2nd gain adjustment, you can expect quicker response.

<Example>

When you want to reduce the noise produced during the stopping (servo-locking), you set the lower gain after the motor stops.

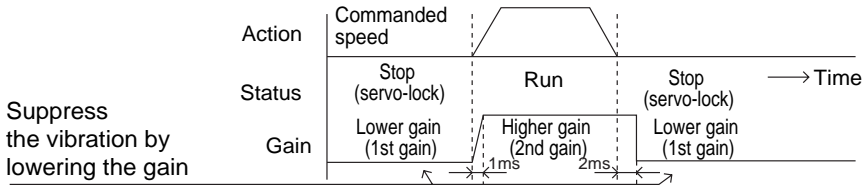

Parameter No.	Parameter description	Guidance value	Concept of adjustment
Pr10	1st position loop gain	Value same as the 2nd position loop gain	—
Pr11	1st velocity loop gain	Value same as the 2nd velocity loop gain	OK, if there is no unusual running noise at servo lock in stop. If unusual noise is found, make the value smaller.
Pr12	1st velocity loop integration time constant	5 0	OK, if there is no problem with the motion. With a smaller value, responsibility improves. With an excessively small value, oscillation occurs.
Pr13	1st velocity detection filter	0	Fixed set-up
Pr14	1st torque filter time constant	Value same as the 2nd torque filter time constant	OK, if there is no unusual running noise at servo lock in stop. If unusual noise is found, change the value.
Pr18	2nd position loop gain	5 0	OK, if there is no problem with the motion. With a larger value, responsibility improves. With an excessively large value, oscillation occurs.
Pr19	2nd position loop gain	3 0	OK, if there is no unusual running noise. If unusual noise is found, make the value smaller.
Pr20	Inertia ratio		First, make the set-up correctly.
Pr30	2nd gain operation set-up	1	—
Pr31	Position control changeover mode	7	—
Pr1A	2nd velocity loop integration time constant	1 0 0 0	—
Pr1B	2nd velocity detection filter	0	Fixed set-up
Pr1C	2nd torque filter time constant	5 0	OK, if there is no unusual running noise. If unusual noise is found, change the value.

<Notes> For setting parameters for other control modes, see Appendix.

# Adjustments

## Gain Tuning Using Gain Adjustment Rotary Switch

Set the rotary switch depending on machine configuration. Then while checking movement of machine, increase the rotary switch value one by one.

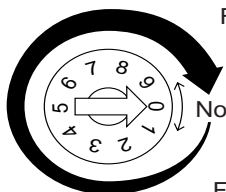

For increasing gain

Note  
When the number gets larger, gain will be increased.

For lowering gain

<Notes>

\*Do not operate rapid change of the value such as 9 to 0 or 0 to 9. Otherwise the motor will oscillate, which results in abnormal sound and vibration.

## Relationship between Gain Adjustment Rotary Switch Value and Inertia

RSW setting	Position Loop Gain	Velocity Loop Gain	Inertia Ratio
0 [factory setting]	Values of Pr10 and Pr18	Values of Pr11 and Pr19	Value of Pr20
1	Value of Pr10 (Standard factory setting: 100)	Value of Pr11 (Standard factory setting: 100)	5 0
2			1 0 0
3			1 5 0
4			2 0 0
5			3 0 0
6			4 0 0
7			5 0 0
8			7 5 0
9			1 0 0 0

<Notes>

- Set the rotary switch to "0" position when setting automatic gain tuning or parameters.
- Set up the RSW to "0" when using the 2nd gain.

## To reduce the mechanical resonance

If the machine is not stiff, vibration and noise may be generated due to the resonance by shaft torsion, and you may not be able to set-up the higher gains. You can suppress the resonance by 2 types of the filters.

### 1. Torque command filter (Pr14 and Pr1C)

Set the filter's time constant so that the frequency components around the resonance region can be attenuated.

You can obtain the cutoff frequency (fc) by the following formula;

Cutoff frequency, fc (Hz) =

$$1/(2\pi \times \text{Parameter value} \times 0.00001)$$

### 2. Notch filter (Pr1D and Pr1E)

Adjust the notch frequency of the filter to the resonance frequency.

<b>Pr1D</b>	Notch frequency	Set this about 10% lower than the resonance frequency measured by the frequency characteristics analysis function of PANATERM®.
<b>Pr1E</b>	Notch width selection	Use the default value of 2.

Resonance characteristics

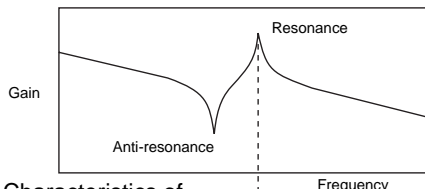

Characteristics of notch filter

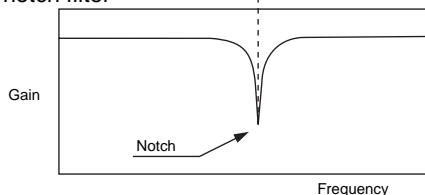

## How to measure the resonance frequency of a machine system

- 1) Log-on PANATERM® and open the frequency characteristics screen.
- 2) Set the following parameters and measuring conditions. Note that the values shown below are only guidance.
  - Decrease the value of Pr11 (1st Velocity Loop Gain) to 25 (to make the resonance frequency more distinguishable).
  - Set the amplitude to 50 r/min (so that the torque may not saturate).
  - Set the offset to 100 r/min. (to increase the amount of velocity detection information, and run the motor in one-way rotation).
  - Polarities: (+) for CCW and (-) for CW.
  - Set the sampling rate to 1 (from a range between 0 and 7).
  - Start the frequency characteristics analysis function.

<Notes>

- Before starting the measurement, make sure that the machine does not move beyond the limit.

Approximate speed = Offset (r/min.) x 0.017 x (Sampling rate + 1)

With a larger offset value, good results can be obtained, though the speed becomes higher.

- Set-up Pr21 (Real time auto tuning mode set-up) to 0.

<Notes>

- Set-up the offset larger than the amplitude setting, and with one-way rotation so that you can obtain better results.

# Protective Functions

## What are the Protective Functions?

- The amplifier has various protective functions. When one of the protections is activated, the motor trips according to the timing chart shown in "Error Handling" in Appendix, and the Servo Alarm Output (ALM) is turned off.
- Actions to be taken after trip events
  - After a trip event, the status LED (STATUS) on the front panel will be turned in red, and the alarm code LED display (ALM CODE) will start flashing. No servo-ON occurs.  
For meaning of flashing of alarm code LED, see page 49.
  - Any trip status can be cleared by keeping A-CLR (Alarm Clear Input) on for at least 120 ms.
  - The overload protection can be cleared by A-CLR at least 10 seconds after the occurrence of the event. If the main power supply of amplifier turns off, the time limiting operation is cleared.
  - The alarms mentioned above can also be cleared by using PANATERM®.

### <Notes>

Protections marked with \* cannot be cleared with A-CLR (Alarm Clear Input). They should be cleared by turning the power off, removing the causes, and then turning the power on again.

Alarms of undervoltage protection (Alarm Code No. 11), EEPROM parameter error protection (Alarm Code No. 36), EEPROM check code error protection (Alarm Code No. 37) and drive inhibit input protection (Alarm Code No. 38) are not stored in the Alarm History.

## Protective Functions: Causes and Corrections

Protection	Alarm Code No.	Cause	Countermeasures
Undervoltage	1 1	<p>The P-N voltage of the main power converter is lower than the specified voltage during Servo-ON.</p> <ol style="list-style-type: none"> <li>1) The main power line voltage is too low. An instantaneous outage occurred.</li> <li>2) Too small power source: The line voltage dropped due to the in-rush current at power on.</li> <li>3) Open phase: Operating with a single phase from the main power in spite of 3-phase specifications.</li> <li>4) The amplifier (circuit) failed.</li> </ol>	<p>Measure the terminal-to-terminal voltage (between L1, L2 and L3).</p> <ol style="list-style-type: none"> <li>1) Increase the capacity of the main power or replace it with a larger one. Or remove the causes of the failure of the magnetic contact, and then restart the power source.</li> <li>2) Increase the capacity of the main power. For the required capacity, see "List of Applicable Equipment".</li> <li>3) Correct the phase (L1, L2 and L3) connection of the main power. If the main power is single-phase 100V or single-phase 200V, use L1 and L3.</li> <li>4) Replace with a new amplifier.</li> </ol>
Overvoltage error	1 2	<p>The line voltage is larger than the specified acceptable range, so that the P-N voltage of the converter is larger than the specified value, or the line voltage was raised by a advancing capacitor or UPS (Uninterruptible Power Supply).</p> <ol style="list-style-type: none"> <li>1) The internal regenerative discharge resistor is disconnected.</li> <li>2) The external regenerative discharge resistor is not suitable so that regenerative energy cannot be absorbed.</li> <li>3) The amplifier (circuit) failed.</li> </ol>	<p>Measure the terminal-to-terminal voltages (between L1, L2 and L3). Remove the causes. Feed a power of correct voltage. Except phase advancing capacitor</p> <ol style="list-style-type: none"> <li>1) Measure the resistance value of the external resistor installed between P and B amplifier terminals using a tester. If it read ÁÁ, the connection is broken. Replace the external resistor.</li> <li>2) Use a resistor having the specified resistance for specified rated power.</li> <li>3) Replace with a new amplifier.</li> </ol>

# Protective Functions

Protection		Cause	Countermeasures
*Overcurrent error		<p>The current flowing in the converter is larger than the specified value.</p> <ol style="list-style-type: none"> <li>1) The amplifier failed (due to defective circuits or IGBT parts).</li> <li>2) Motor wires (U, V and W) are shorted.</li> <li>3) Motor wires are grounded.</li> <li>4) Motor burned</li> <li>5) Poor connection of Motor wires</li> <li>6) The relay for the dynamic brake is melted and stuck due to the frequent Servo-ON/OFF.</li> <li>7) The motor is not compatible with the amplifier.</li> <li>8) Pulse input and Servo-ON occurs simultaneously, or pulse input occurs faster than Servo-ON.</li> </ol>	<ol style="list-style-type: none"> <li>1) Disconnect the motor wires, and enter Servo-ON. If this trouble happens immediately, replace the amplifier with a new one (that is working correctly).</li> <li>2) Check if the U, V and W wires are shorted at the connections. Reconnect them, if necessary.</li> <li>3) Measure the insulation resistance between U/V/W and earth wire. If the resistance is not correct, replace the motor with a new one.</li> <li>4) Measure the resistance between U, V and W. If they are unbalanced, replace the motor with a new one.</li> <li>5) Check if the U/V/W connector pins are firmly secured with screws. Loosened pins should be fixed firmly.</li> <li>6) Replace the amplifier with a new one. Do not start or stop the motor by entering Servo-ON or OFF.</li> <li>7) Check the capacity of the motor and amplifier on the nameplate. If the motor is not compatible with the amplifier, replace it with a correct one.</li> <li>8) Pulse input should occur after at least 100 ms following Servo-ON. Refer to Appendix "Timing Chart".</li> </ol>

Protection	Alarm Code No.	Cause	Countermeasures
Overload error	1 6	<p>Overload protection is activated via the specified time limiting operation when the integration of a torque command exceeds the specified overload level.</p> <ol style="list-style-type: none"> <li>1) Caused by a long operation with a torque that exceeds the specified torque limit.</li> <li>2) Vibration or hunting due to incorrect gains. Cause vibration and/or abnormal sound. Adjustment of inertia ratio, set value of Pr20, is required.</li> <li>3) Motor wires connected wrong or broken</li> <li>4) The machine is hit against a heavy thing, or suddenly becomes heavy in operation. The machine is entangled.</li> <li>5) The electromagnetic brake is ON.</li> <li>6) In a system of multiple amplifiers, some motors are wired incorrectly to other axis.</li> </ol>	<p>Check on waveform graphic screen of PANATERM“ whether the torque (current wave) is surging or not. Check the overload alarm message and load factor using PANATERM“.</p> <ol style="list-style-type: none"> <li>1) Increase the capacity of the amplifier and motor. Lengthen the ramp time of acceleration/deceleration. Re-duce the motor load.</li> <li>2) Readjust the gains. Adjust setting of the rotary switch.</li> <li>3) Correct the motor wiring per the wiring diagrams. Replace cables.</li> <li>4) Free the machine of any tangle. Reduce the motor load.</li> <li>5) Measure the voltage at the brake wiring connections. Turn off the brake.</li> <li>6) Correct the motor and encoder wiring to eliminate the mismatching.</li> </ol>
Regenerative discharge	1 8	<p>The regenerative energy is larger than the capacity of the regenerative discharge resistor.</p> <ol style="list-style-type: none"> <li>1) When the load inertia is too large, he converter voltage increases due to the large energy regenerated during deceleration, and increases more due to the shortage energy consumption by the regenerative discharge resistor.</li> <li>2) When the velocity of the motor is too high, the regenerative energy cannot be consumed within the specified deceleration time.</li> <li>3) Operation of external resistor is limited to 10% duty.</li> </ol>	<p>Check regenerative discharge resistor load factor on monitor screen of PANATERM“. The amplifier should not be used with continuous regenerative braking.</p> <ol style="list-style-type: none"> <li>1) Check the operation pattern (using the velocity monitor). Check the load rate of the regenerative resistor and the over-regeneration alarm on display. Increase the capacity of the amplifier and motor. Increase the deceleration time. Use an external regenerative resistor.</li> <li>2) Check the operation pattern (using the velocity monitor). Check the load rate of the regenerative resistor and the over-regeneration alarm on display. Increase the capacity of the amplifier and motor. Increase the deceleration time. Reduce the motor rpm. Use an external regenerative resistor.</li> <li>3) Set "2" on Pr6C.</li> </ol>
		<p>&lt;Notes&gt; When setting Pr6C to "2", don't fail to install external protection such as thermal fuse. Otherwise, regenerative discharge resistor is not protected any more to cause possible abnormal heat generation, resulting in burning of the motor.</p>	

Important Information

# Protective Functions

	Alarm Code No.	Cause	Countermeasures
* Encoder A/ B-phase error	2 0	No encoder A- and B-phase pulse is detected. The encoder failed.	Correct the encoder wiring per the wiring diagram. Correct the connection of the pins.
* Encoder communication error	2 1	Due to no communication between the encoder and amplifier, the detective function for broken encoder wires is activated.	
* Encoder connection error	2 2	The connection between the encoder and amplifier is broken.	Make sure that the power of the encoder is 5VDC $\pm$ 5% (4.75 to 5.25V). Especially when the wire length is long, it is important to meet this requirement. You should not bundle the encoder wires and motor wires together. Connect the shield to FG. See the encoder wiring diagram.
* Encoder communication data error	2 3	The encoder sends an erroneous data mainly due to noises. The encoder is connected correctly, though the data is not correct.	
Position error	2 4	The position error pulse is larger than Pr63 (position error limit). 1) Operation of the motor does not follow the commands. 2) Pr63 value (Position error limit) is smaller.  ]	1) Check whether the motor operates per the position command pulse or not. See the torque monitor to check if the output torque is saturated. Readjust the gains. Maximize the value of Pr5E (torque limit set-up). Correct the encoder wiring per the wiring diagram. Increase the acceleration and deceleration time. Reduce the load and velocity. 2) Increase the value of Pr63.
Over-speed error	2 6	The motor velocity exceeds the specified limit.	Do not give excessive speed commands. Check the frequency of the command pulse and scale ratio. If an overshoot occurs due to wrong gain adjustment, readjust the gains. Correct the encoder wiring per the wiring diagram.
Command pulse sealer error	2 7	The scale ratios set by Pr46 through Pr4B (numerator of 1st to 4th command scale) are not correct.	Check the set values of Pr46 through 4B. Adjust the scale ratio so that the frequency of the command pulse may be 500 kpps or less.

Protection	Alarm CodeNo.	Cause	Countermeasures
Error counter over flow	2 9	The value of the position error counter is over $2^{27}$ (134217728).	Check that the motor operates per the position command pulse. See the torque monitor to check that the output torque does not get saturated. Readjust the gains. Maximize the value of Pr5E (torque limit setup). Correct the encoder wiring.
* EEPROM parameter error	3 6	The data contained in the parameter storage area of the EEPROM is broken,	Set all the parameters again. If this error occurs frequently, the amplifier may have been broken. Replace the amplifier with a new one. Return the old amplifier to the sales agent for repair.
* EEPROM check code error	3 7	The check code of the EEPROM is broken,	The amplifier may have been broken. Replace the amplifier with a new one. Return the old amplifier to the sales agent for repair.
Overttravel inhibit	3 8	Both the CW and CCW over-travel limits are not active.	Check the switches, wires and power supply that constitute the circuits. Check that the control power (12 to 24VDC) can be established without delay. Check the value of Pr04. Correct the wiring, if necessary.
* Other error	9 9	The control circuit operates incorrectly due to large noises or any other reasons. The amplifier's self-diagnosing function is activated, because an error happens in the amplifier.	Turn off the power and turn it on again. If the error cannot be eliminated, the motor and/or amplifier may be broken. Discontinue use of the motor, and replace the motor and the amplifier. Return the old equipment to the sales agent for repair.
	*		

\*) Status LED indicator (STATUS) and alarm code LED indicator (ALM CODE) start flashing simultaneously.

Status LED	Alarm code LED
● red	● red
● red	● orange
● orange	● red
● orange	● orange

# Maintenance and Inspections

⚠ Routine maintenance and inspections are essential for proper and satisfactory operation of the amplifier and motor.

## Notes to Maintenance/Inspections Personnel

- 1) Power-on/off operations should be done by the operators themselves.
- 2) For a while after power off, the internal circuits is kept charged at higher voltage. Inspections should be done a while (about 10 minutes), after the power is turned off and the LED lamp on the panel is extinguished.
- 3) Do not take insulation resistance measures because the amplifier gets damaged.

## Inspection Items and cycles

Normal (correct) operating conditions:

Ambient temperature: 30 °C (annual average) Load factor: max. 80%  
Operating hours: max. 20 hours per day

Daily and periodical inspections should be done per the following instructions.

Type	Cycles	Inspection items
Daily inspection	Daily	<ul style="list-style-type: none"><li>• Ambient temperature, humidity, dust, particles, foreign matters, etc.</li><li>• Abnormal sound and vibration</li><li>• Main circuit voltage</li><li>• Odor</li><li>• Lint or other foreign matters in the ventilation openings</li><li>• Cleanliness of the operation board</li><li>• Damaged circuits</li><li>• Loosened connections and improper pin positions</li><li>• Foreign matters caught in the machine (motor load)</li></ul>
Periodical inspection	Every year	<ul style="list-style-type: none"><li>• Loosened screws</li><li>• Signs of overheat</li></ul>

### <Notes>

If the actual operating conditions differ from things mentioned above, the inspection cycles may change accordingly.

## Replacement Guidance

Parts replacement cycles depend on the actual operating conditions and how the equipment has been used. Defective parts should be replaced or repaired immediately.

 Prohibited	Dismantling for inspections or repairs should be done by our company (or our sales agents).
---	---

Equipment	Part	Standard replacement cycles (hour)	Remarks
Amplifier	Smoothing condenser	about 5 years	The replacement cycles shown here are just only for reference. If any part is found defective regardless of the standard replacement cycles, immediately replace it with a new one.
	Aluminum electrolytic capacitor on the print board	about 5 years	
Motor	Bearing	3 to 5 years <small>(20 to 30 thousand hours)</small>	
	Oil seal	5000 hours	
	Encoder	3 to 5 years <small>(20 to 30 thousand hours)</small>	

# Troubleshooting

The motor does not rotate.

[Check Points]

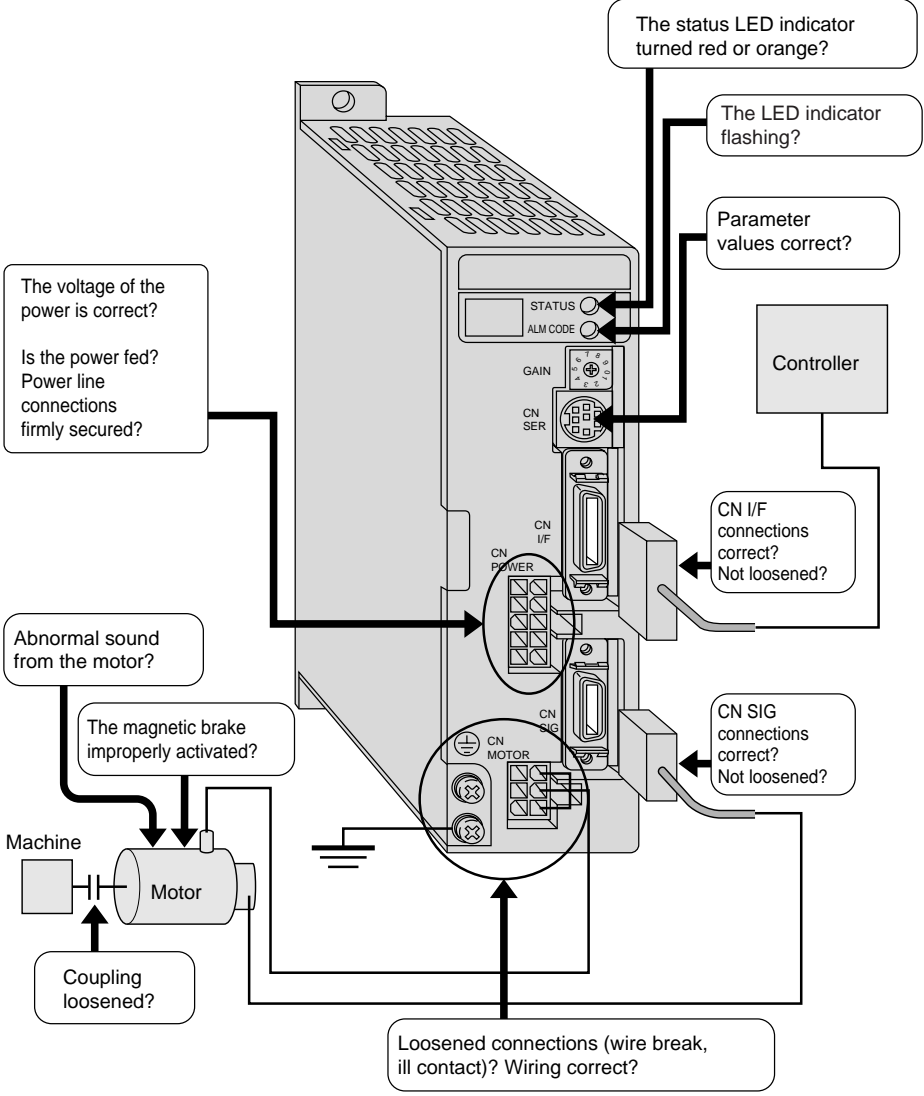

The motor does not rotate.

Category	Causes	Countermeasures
Parameters	The control mode selected is not correct.	Check the value of Pr02 (control mode set-up). 0: position control, 1: internal velocity control.
	The torque limit has been set to 0.	Check the value of Pr5E (torque limit set-up). Change the value to 300 (default).
	The zero speed clamp is ON, so the motor does not operate.  Internal velocity set-up parameter is not entered.	Check the value of Pr06 (ZERPSPD input selection). Change the value to 0. If the value is 1, the zero clamp function is valid. If you desire to set the parameter to 1, enable the zero speed clamp input, and adjust the wiring so that the zero speed clamp input can be turned on correctly. Check the values of Pr53 through Pr56. Set a desirable number of revolution.
Wiring	The circuit for CW/CCW overtravel inhibit is open.	Check the value of Pr04. If the value is 0, connect between CN I/F pins 8 and 13, and 7 and 13.
	CN I/F Servo-ON signal is not received.	Connect (short circuit) between CN I/F pins 2 and 13.
	CN I/F counter clear is ON (shorted).	Disconnect between CN I/F pins 4 and 13.
Installation	Motor lock	Turn off the power. Disconnect the motor. Rotate the motor shaft by hand to make sure that the motor rotates freely. If the motor is fitted with an electromagnetic brake, rotate the shaft by hand while applying a voltage (24VDC) to the brake. If the motor does not rotate, consult the sales agent to repair it.

Parameter values change to the former value.

Category	Causes	Countermeasures
Parameter	Parameter values are not downloaded into EEPROM before power off.	See "Parameter Setting" chapter.

# Troubleshooting

The rotation is not smooth.

Category	Causes	Countermeasures
Adjustment	The gains are not appropriate.	Increase the value of Pr11 (1st velocity loop gain). Set a torque filter (Pr14) and then further increase the value of Pr11.
	Position commands are not stable.	Check the behavior of the motor on the waveform graphic screen of PANATERM <sup>™</sup> using the CN MON check pin. Check the wiring and its connections. Check the controller.
Wiring	CN I/F signals are chattering. 1) Servo-ON signal  2) Counter clear input signal  3) Zero speed clamp input Internal command speed selection 1, 2	1) Check the wiring and connections between CN I/F pins 2 and 13 by monitoring the display of input and output signals status. Modify the wiring so that Servo-ON signals can be made active correctly. Check the controller. 2) Check the wiring and connections between CN I/F pins 4 and 13 by monitoring the display of input and output signals status. Modify the wiring so that the position error counter clear input can be made active correctly. Check the controller. 3) Check the wiring and connections between CN I/F pins 5 and 13, 4 and 13, and 6 and 13 by monitoring the display of input and output signals status. Modify the wiring so that Zero Speed Clamp input can be made active correctly. Check the controller.

Positioning accuracy is bad.

Category	Causes	Countermeasures
System	Position commands (amount of command pulses) are not correct.	Count the number of feedback pulses on the monitor screen of PANATERM <sup>®</sup> while repeating travel to back and forth within a fixed distance. If the number of feedback pulses varies, adjust the controller. Take measures to reduce the noise on the command pulse.
	Reading of in-position signals occurs at the edge.	Use the waveform graphic screen of PANATERM <sup>®</sup> to monitor the position error when the in-position signals are received. Read the in-position signals at a mid point on the time span, not at the edge.
	The form and width of the command pulses deviate from the specified values.	If the command pulses are deformed or narrowed, adjust the pulse generation circuit. Take measures to reduce the noise on the command pulse.
Adjustment	The position loop gain is too small.	Check the amount of position error on the monitor screen of PANATERM <sup>®</sup> . Increase the value of Pr10 to the extent that no oscillation occurs.
Parameter	The setting of in-position detection range (Pr60) is too large.	Decrease the value of Pr60 (in-position range) to the extent that the in-position signals do not chatter.
	The command pulse frequency exceeds 500 kpps.	Decrease the command pulse frequency. Change the values of Pr46 through Pr47 (numerator of 1st to 2nd command scale).
Wiring	CN I/F signals are chattering: 1) Servo-ON signals  2) Counter clear input	1) Check the wiring and connections between CN I/F pins 2 and 13 by monitoring the display of input and output signals status. Modify the wiring so that Servo-ON signals can be made active correctly. Check the controller. 2) Check the wiring and connections between CN I/F pins 4 and 13 by monitoring the display of input and output signals status. Modify the wiring so that the position error counter clear input cannot be made active during operation. Check the controller.
Installation	Load inertia is large.	Check the overshoot at stop using the wave form graphics function of PANATERM <sup>®</sup> . Adjust the gains. If this is not effective, increase the capacity of the amplifier and motor.

# Troubleshooting

The initial (home) position varies.

Category	Causes	Countermeasures
System	When calculating the initial (home) position, the Z-phase output is not detected.	Check that the Z-phase accords to the center of the proximity dog. Perform initialization correctly according to the controller.
	Creep speed to initial position is too high.	Decrease the return speed near the initial (home) position, or lengthen the initialization sensor.
Wiring	The output of the initial (home) position proximity sensor (dog sensor) is chattering.	Check the input to the sensor using an oscilloscope. Modify the wiring around the sensor. Take measures to reduce the noise.
	Noise on encoder wires	Take measures to reduce the noise (noise filters, ferrite cores, etc.). Properly connect the shield wires of I/F cables. Use twist-paired wires. Separate the signal and power wires.
	Z-phase signal is not output.	Monitor the Z-phase signal using an oscilloscope. Check that the ground terminal 14 of CN I/F CZ (Z phase signal open collector output) is connected to the ground terminal of the controller. Replace the amplifier and controller, or repair them.
	The circuit for Z-phase signal is not correct.	Check that the line amplifier is connected at the both sides. If the controller does not have a differential input, use CZ (Z phase signal open collector output).

The motor produces an abnormal sound and/or vibration.

Category	Causes	Countermeasures
Adjustment	The gains are too large.	Decrease the values of Pr10 (position loop gain) and Pr11 (velocity loop gain). Change the value of rotary switch gain.
	The velocity detection filter is not proper.	Increase the value of Pr13 (speed detection filter) until the sound decreases to an acceptable level, or return the value to 4 (default).
Installation	Resonance between the machine and motor occurs.	Adjust the value of Pr14 (Torque filter time constant). Check the mechanical resonance using the frequency characteristics analysis program in PANATERM*. If a resonance occurs, set Pr1D(notch frequency).
	Motor bearing	Operate the motor without load in order to check the sound and vibration near the bearing. Replace the motor and operate it to do the same checks. Repair the motor, if necessary.
	Electromagnetic sound, gear sound, braking sound, hub sound, rubbing sound from the encoder, etc.	Operate the motor without load or use a new motor in order to locate the source of sounds. Repair the motor, if necessary.

# Troubleshooting

## Overshoot or undershoot

### The motor overheats (burnt)

Category	Causes	Countermeasures
Adjustment	Gains are not correct.	Check the gains using the wave form graphics monitoring function of PANATERM®, speed monitor (SP) and/or torque monitor (IM). Adjust the gains. See "Adjustments" chapter.
Installation	Load inertia is too large.	Check the load inertia using the wave form graphics monitoring function of PANATERM®, speed monitor Check the coupling between the motor and machine. Increase the capacity of the motor and amplifier use a geared motor to decrease inertia ratio.
	Rattling or slip of the machine	Check the fitting part of the machine.
	Environment (ambient temperature, etc.)	If the ambient temperature is higher than the specified value, install a cooling fan.
	The cooling fan does not work. The air intake is dirty.	Check the cooling fan of the amplifier.
	Mismatch between the amplifier and motor	Check the nameplates of the amplifier and motor. For available combinations between amplifier and motor, see the instruction manuals or catalogues.
	Motor bearings fail.	Turn off the power. Rotate the motor shaft by hand to check whether abnormal sound (rumbling) occurs or not. If it rumbles, replace it with a new one, or repair it.
	The electromagnetic brake is ON (failure to release the brake).	Check the voltage at the brake terminal. Apply 24VDC to release the brake.
	The motor fails (due to oil, water, etc.).	Avoid high temperature/humidity, oil, dust and iron powders.
	The motor is operated by external forces while the dynamic brake is activated.	Check the operation pattern, use and working status. This kind of operation should be avoided.

### The motor speed does not increase up to the specified value.

### The speed (movement) is too large or small.

Category	Causes	Countermeasures
Adjustment	The position loop gain is too small.	Adjust the value of Pr10 (position loop gain) to approximately 100.
	The scale is not appropriate.	Correct the values of Pr46 (numerator of 1st command pulse ratio), Pr4A (Multiplier of numerator of command pulse ratio) and Pr4B (denominator of pulse command ratio). See "Details of Parameters" chapter.

# Appendixes

Conform to EC Directives and UL Standards	App. 2
Holding brake	App. 6
Dynamic brake	App. 8
Timing chart	App. 10
Allowable loads on output axes	App. 14
Homing operation (Precautions)	App. 15
Details of Parameters	App. 16
Optional Parts (Amplifier power connection connector kit, encoder relay cable, motor replay cable, motor brake relay cable, monitor connector, motor encoder connection connector kit, controller connection connector kit, connector connection interface cable, communication cable, communication control software [PANATERM <sup>®</sup> ], external regenerative discharge resistor, reactor)	App. 38
Recommended Parts	
• Surge absorber for motor brake	App. 47
• List of peripheral equipment manufacturers	App. 47
Outer Views and Dimensions	
• Motor	App. 48
• Amplifier	App. 50
Properties	
• Overload protection: time-related characteristics	App. 53
Specifications	
• Gain switching conditions for each control mode	App. 54
• Block diagrams	App. 56
• Specifications of amplifier	App. 58

# Conformance to EC Directives and UL Standards

## EC Directives

The EC Directives apply to all such electronic products as those having specific functions and directly sold to general consumers in EU countries. These products are required to meet the EU unified standards and to be furnished with CE Marking.

However, our AC servos meet the EC Directives for Low Voltage Equipment so that the machine or equipment comprising our AC servos can meet relevant EC Directives.

## EMC Directives

Our servo systems can meet EMC Directives and related standards. However, to meet these requirements, the systems must be limited with respect to configuration and other aspects, e.g. the distance between the servo amplifier and motor is restricted, and some special wiring conditions must be met. This means that in some cases machines and equipment comprising our servo systems may not satisfy the requirements for wiring and grounding conditions specified by the EMC Directives. Therefore, conformance to the EMC Directives (especially the requirements for emission noise and noise terminal voltage) should be examined based on the final products that include our servo amplifiers and servo motors.

## Applicable Standards

Subject	Applicable standard		
Motor	IEC60034-1		Standards referenced by Low-Voltage Directive
Motor and amplifier	EN50178		
	IEC61800-3	EMC Requirements for Variable Speed Electric Power Driven Systems	Standards referenced by EMC Directives
	EN55011	Radio Disturbance Characteristics of Industrial, Scientific and Medical (ISM) Radio-Frequency Equipment	
	IEC61000-4-2	Electrostatic Discharge Immunity Test	
	IEC61000-4-3	Radio Frequency Electromagnetic Field Immunity Test	
	IEC61000-4-4	Electric High-Speed Transition Phenomenon - Burst Immunity Test	
	IEC61000-4-5	Lightening Surge Immunity Test	
	IEC61000-4-6	High Frequency Conduction - Immunity Test	
	IEC61000-4-11	Instantaneous Outage - Immunity Test	

EC: International Electrotechnical Commission

EN: Europaischen Normen

EMC: Electromagnetic Compatibility

## Peripheral Equipment

### Environment

The servo amplifier should be used under Contamination Level 2 or 1 specified by IEC60664-1 (housing the amplifier in an IP54 control box).

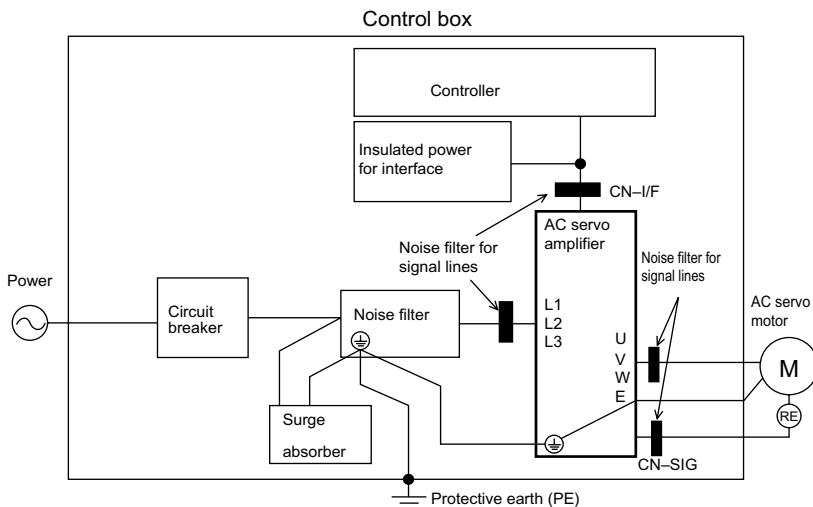

### Power

Single-phase 100V : Single-phase 100 to 115V +10%/-15%, 50/60Hz

Single-phase 200V : Single-phase 200 to 230V +10%/-15%, 50/60Hz

Three-phase 200V : Three-phase 200 to 230V +10%/-15%, 50/60Hz

(1) Use under the environment of Over-voltage Category III specified by IEC60664-1.

(2) The power for interface should be marked CE or appropriate EN Standard type, 12VDC to 24VDC, insulated.

### Circuit Breaker

Install a circuit breaker between the power supply and noise filter. The circuit breaker should be IEC Standard and UL listed (UL) marked.

### Noise Filter

If several amplifiers are used, and a single noise filter is installed at the power supply, consult the manufacturer of the noise filter.

# Conformance to EC Directives and UL Standards

## Surge Absorber

Install a surge absorber at the primary side of the noise filter.

<Notes>

When performing a voltage-resisting test, remove the surge absorber. Otherwise the absorber may be damaged.

## Install noise filters.

Install noise filters (specially designed for signal wires) for all cables (power, motor, encoder and interface wires).

## Grounding

- (1) Connect between the servo amplifier's protective earth terminal (⊕) and control box's protective earth (ground plate) to prevent electric shocks.
- (2) Multiple connections to a single protective earth terminal (⊕) should be avoided. There are two protective earth terminals.

## Peripheral Devices Applicable to Amplifiers (EC Directives)

## Surge Absorber

Optional Part No.	Manufacturer's Product No.	Manufacturer
DVOP1450	R•A•V-781BXZ-4	Okaya Electric Industries Co., Ltd.

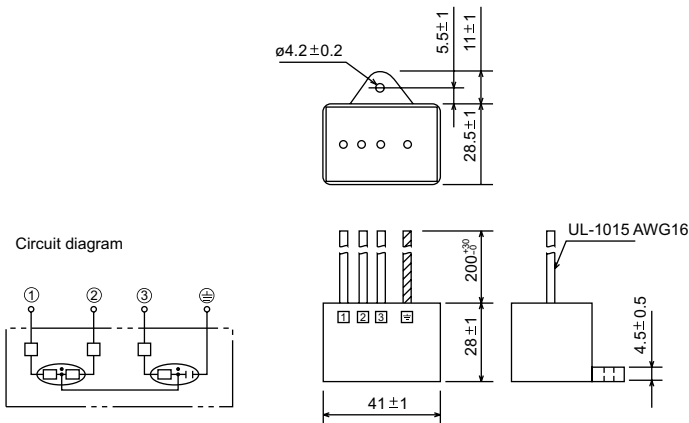

## Install noise filters

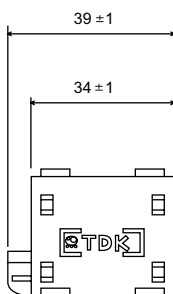

Optional Part No.	Manufacturer's Product No.	Manufacturer
DVOP1460	ZCAT3035-1330	TDK Corporation

Weight: 62.8 g

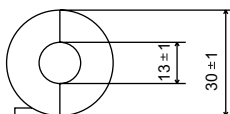

## Noise Filter

Optional Part No.	Manufacturer's Product No.	Manufacturer
DVOP1441	3SUP-A10H-ER-4	Okaya Electric Industries Co., Ltd.
DVOP1442	3SUP-A30H-ER-4	

Circuit diagram

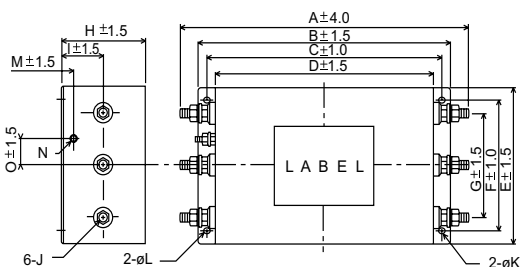
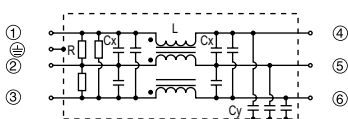

	A	B	C	D	E	F	G	H	I	J	K	L	M	N	O
DVOP1441	188	160	145	130	110	95	70	55	25	M5	4.5	ø4.5×7	10	M4	17.5
DVOP1442	228	200	185	170	110	95	70	60	30	M6	4.5	ø4.5×7	10	M4	17.5

## Conform to UL Standards

The noise filters conform to UL508C (File No. E164620) to satisfy the following conditions.

- 1) The servo amplifier should be used under Contamination Level 2 or 1 specified by IEC60664-1 (housing the amplifier in an IP54 control box).
- 2) Install a circuit breaker or fuse between the power supply and noise filter. The circuit breaker or fuse should be a UL listed  marked type. The current rating of the circuit breaker or fuse should be per the table in page 20.

# Holding brake

The brake is to hold the work (movable part coupled to a vertical motor axis) to prevent it from falling by gravity in case the servo power is lost.

<Caution>

The holding brake is to hold the work, not stop its motion. Never use the brake for decelerating and stopping the machine.

## Wiring (Example)

This circuit shows a function of controlling the brake using the brake release signal (BRK-OFF) from the amplifier.

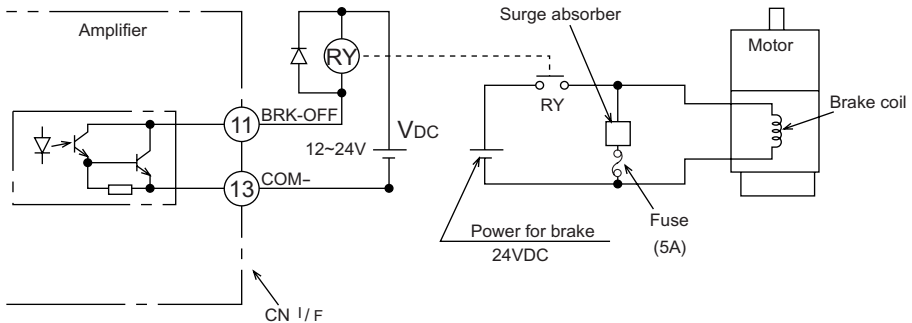

<Notes and Cautions>

1. The brake coil has no polarities.
2. The power supply for the brake should be supplied by the customer. Do not use the control power (VDC) for driving the brake.
3. Install a surge absorber per the figure above in order to suppress the surge voltage due to the on/off operation of the relay (RY). If you use a diode for surge absorber, note that the start of the servo motor after releasing the brake is delayed.
4. Use the recommended surge absorber. See Recommended Parts in page appendix 47.
5. Recommended parts are those specified for measurement of the brake releasing time. They are not provided with sufficient measures to prevent noise. Reactance of the cable varies with the wiring length, possibly resulting in jump-up of the voltage in some cases. Select a surge absorber so that the coil voltage of the relay may be suppressed to (Max. rating: 30V, 50mA max.) and the terminal-to-terminal voltage of the brake to (Max. rating: 30V, 50mA max.).

## BRK-OFF Signal

- See Timing Chart describing the timing of issuing BRK-OFF signal, e.g. to release the brake after power-on, and activate the brake in case a servo-off/ alarm occurs during the operation of the motor.
- The timing (delay) of deactivating BRK-OFF signal (i.e. activating the brake) after the motor is freed into a non-excited status in case of Servo-OFF or alarm event can be adjusted by using Pr6B (brake output delay time set-up at motor in motion). For details, see Details of Parameters.

<Notes>

1. The brake may produce a sound (rattling of brake liner). This is not a problem.
2. When energizing the brake coil (when the brake is off), magnetic flux may leak from the end of the axis. If a magnetic sensor or similar device is used near the motor, make sure that the device is not affected by the magnetic flux.

## Holding Brake Specifications

Motor	Capacity (W)	Static friction torque (N•m)	Inertia x 10 <sup>4</sup> (kg•m <sup>2</sup> )	Absorption time (ms)	Releasing time (ms) *1	Excitation current (DC current (A)) (during cooling)	Releasing voltage	Allowable thermal equivalent of work per braking (J)	Allowable overall thermal equivalent of work (x10 <sup>3</sup> •J)
MUMS	30 ~ 100	0.29 or more	0.003	25 or less	20 or less	0.26	1VDC or more	39.2	4.9
	200, 400	1.27 or more	0.03	50 or less	(30)	0.36		137	44.1
	750	2.45 or more	0.09	60 or less	15 or less (100)	0.43		196	147

Excitation voltage should be 24VDC ±10%

\*1) Delay of DC cutoff in case a surge absorber is used.

( ) means actual values using a diode "V03C" made by HITACHI SEMCON DEVICE Co., Ltd.

The values in this table are representative (except the friction torque, releasing voltage and excitation voltage). The backlash of the brake is factory-set to within ±1 degree.

# Dynamic Brake (DB)

The amplifier has a dynamic brake for emergency use. Observe the following precautions.

<Notes>

1. The dynamic brake should be used for emergency stop only.

**Do not start or stop the motor by switching servo-on signal on or off. Otherwise, dynamic brake circuit may be broken.**

2. The dynamic brake should be on for just a short time for emergency. If the dynamic brake is activated during a high-speed operation, leave the motor stopped for at least three minutes.
  - The dynamic brake can be used in the following cases.
    - 1) Servo-OFF
    - 2) One of the protective functions is activated.
    - 3) Over-travel Inhibit (CWL or CCWL) is activated.

In any of three cases above, the dynamic brake can be activated either during deceleration or after stop, or can be made disabled (i.e. allowing the free running of the motor). These features can be set by using the relevant parameters.

However, if the main power is OFF, the dynamic brake is kept ON.

1) Options of the operation through deceleration and stop by turning on Servo-OFF (Pr69)

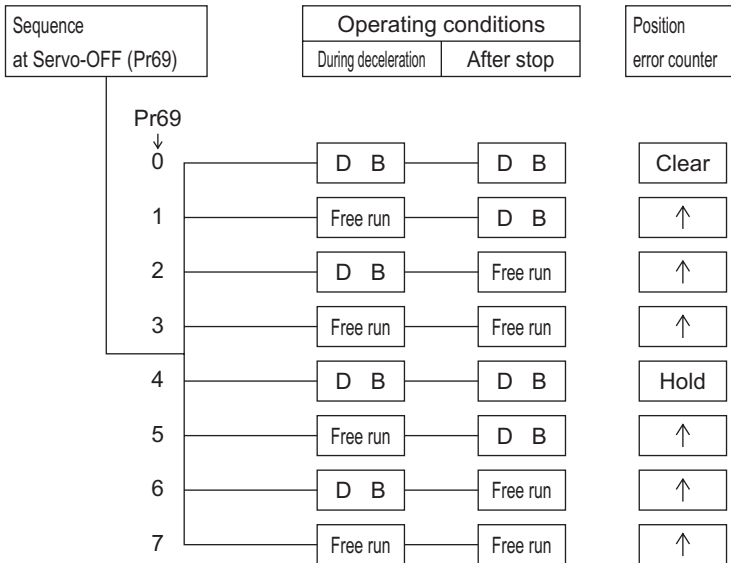

2) Options of the operation through deceleration and stop by turning on a protective function (Pr68)

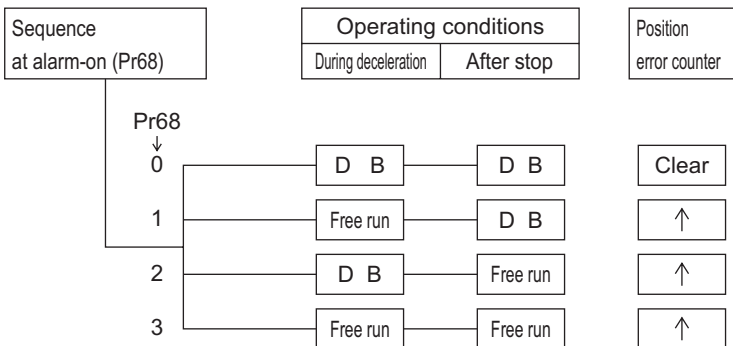

3) Options of the operation through deceleration and stop by turning on Over-travel Inhibit (CWL or CCWL) (Pr66)

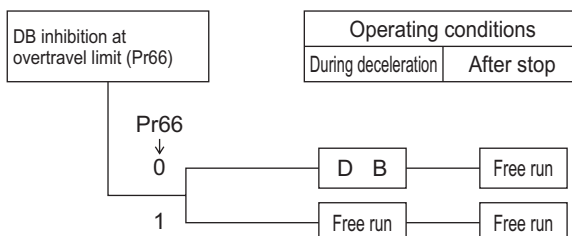

# Timing Chart

After Power ON (receiving Servo-ON signal)

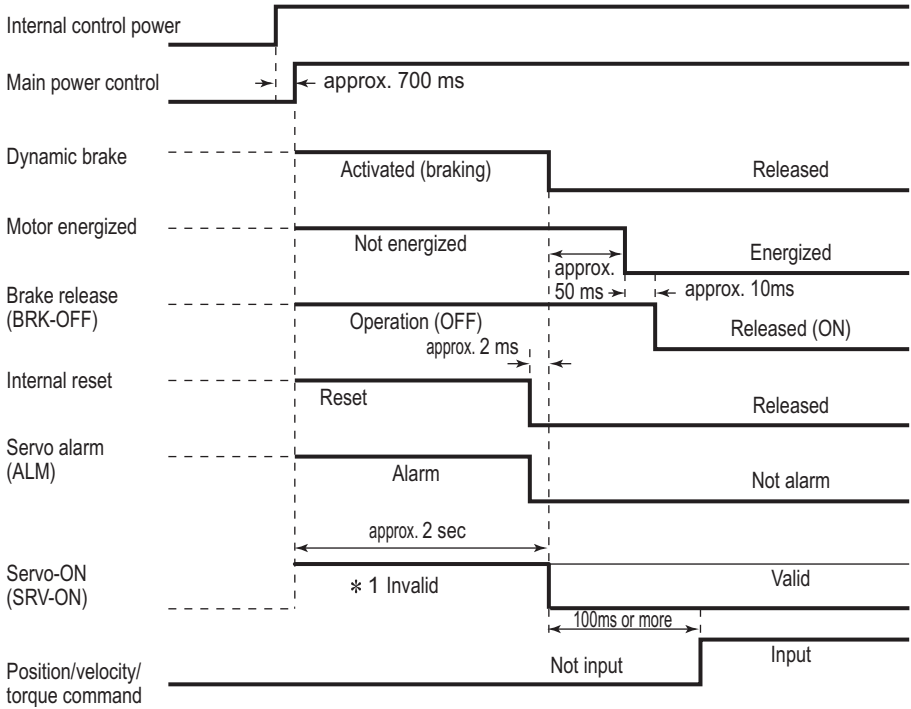

<Caution>

\*1. This means that SRV-ON signal is entered mechanically, but not accepted actually.

<Notes>

- Avoid repeating to switch on and off the main power.
- Switch on the main power in about 1 minute more after it is switched off.

After an Alarm event (during Servo-ON)

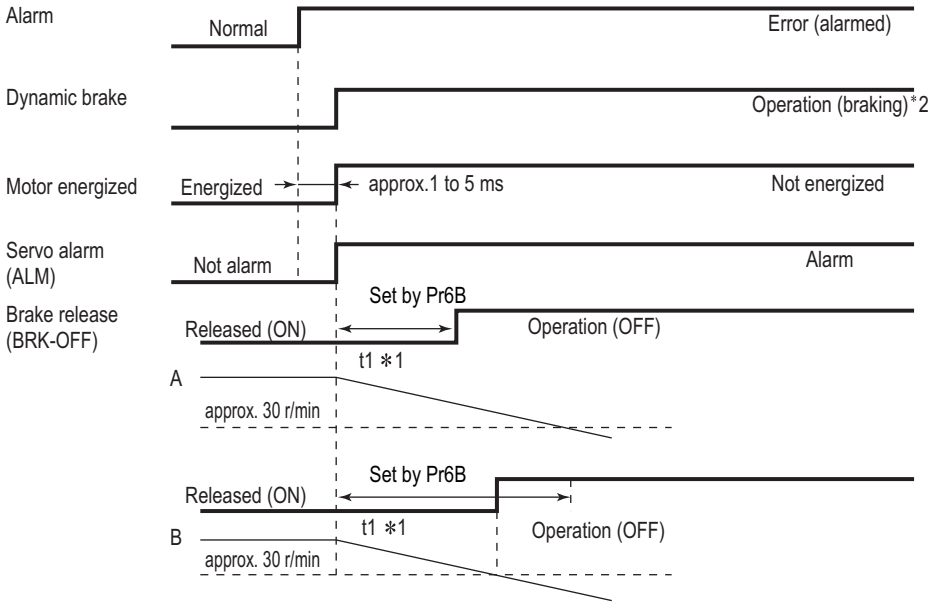

- \*1. The value of  $t1$  is the value of Pr6B or the time needed for decreasing the motor speed to approx. 30 r/min, which is shorter.
- \*2. For the operation of the dynamic brake following an alarm event, see the explanation of Pr68 in "Details of Parameters".

# Timing Chart

## After an Alarm is cleared (during Servo-ON)

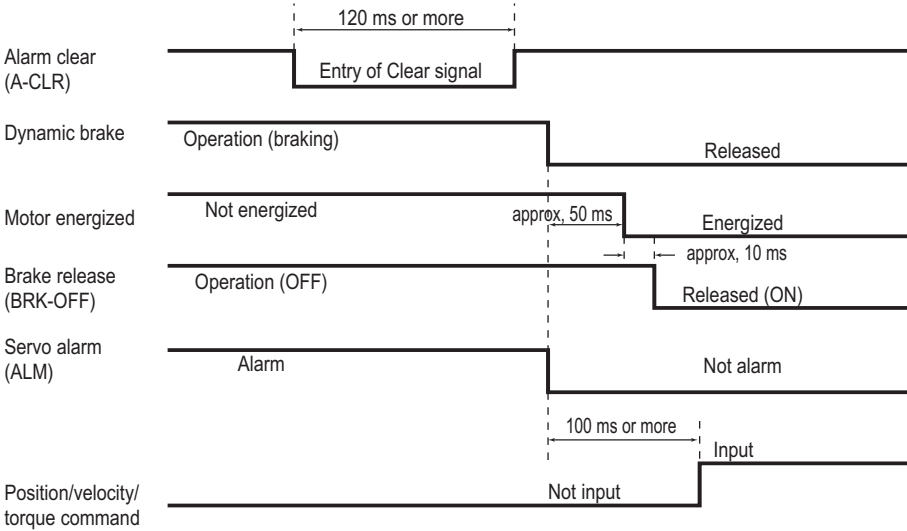

## Servo-ON/OFF operation when the motor is stopped

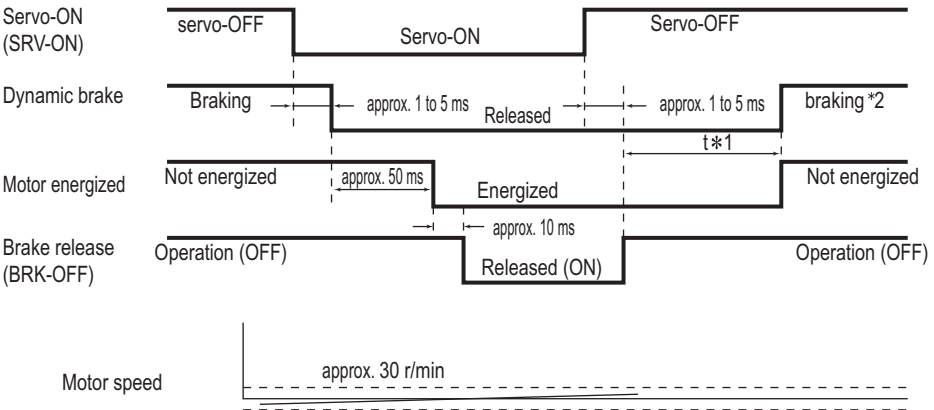

\*1. The value of t depends on the value of Pr6A.

\*2. For the operation of the dynamic brake at Servo-OFF, see the explanation of Pr69 in "Details of Parameters".

## Servo-ON/OFF operation when the motor is in operation

### With Servo-ON entered

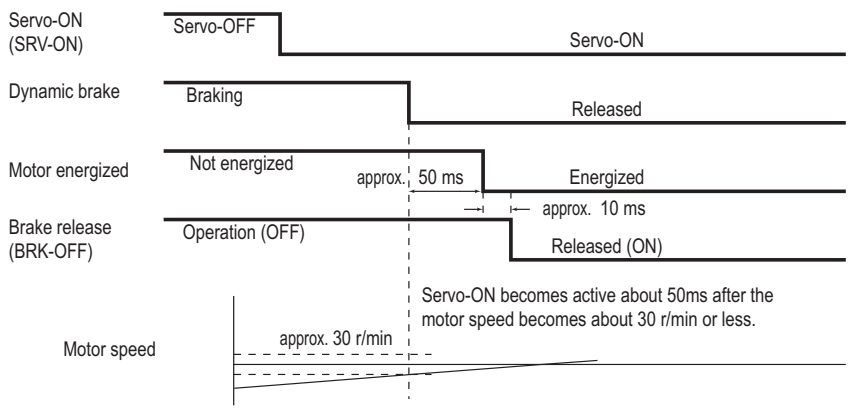

### With Servo-OFF entered

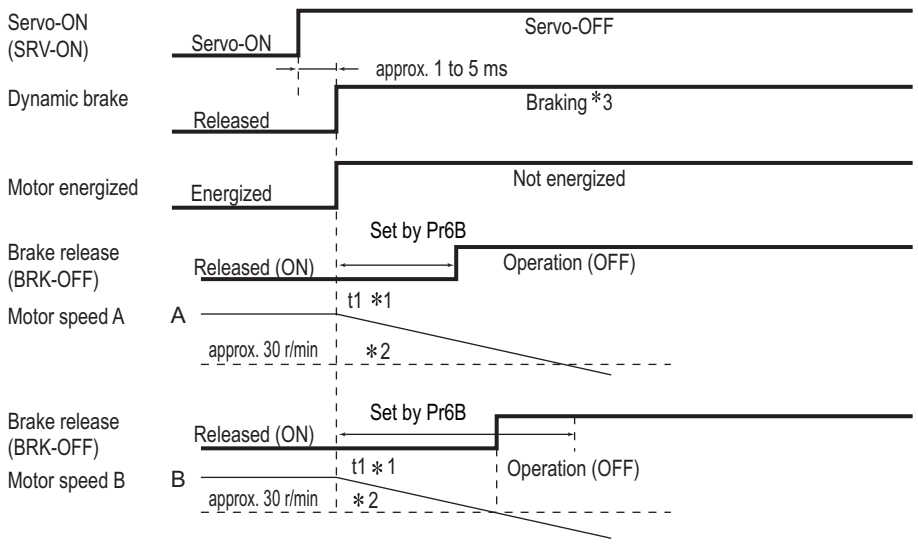

- \*1. The value of t1 is the value of Pr6B or the time needed for decreasing the motor speed to about 30 r/min, which is shorter.
- \*2. During deceleration, Servo-ON does not become active until the motor stops, even if you attempt to turn on SRV-ON again.
- \*3. For the operation of the dynamic brake at Servo-OFF, see the explanation of Pr69 in "Details of Parameters".

# Acceptable Loads on Output Axes

## Acceptable Loads on Output Axes

Radial load (P) direction

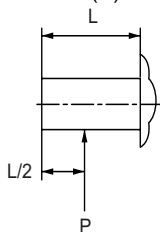

Thrust load (A and B) direction

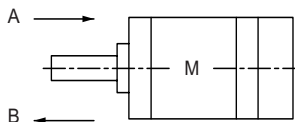

Unit: N (1 kgf = 9.8 N)

Motor series	Motor output	Acceptable during no operation			Acceptable during operation	
		Radial load	Thrust load		Radial load	Thrust load (A or B direction)
			A direction	B direction		
MUMS	30W	147	88	117.6	49	29.4
	50W, 100W				68.6	58.8
	200W, 400W	392	147	196	245	98
	750W	686	294	392	392	147

# Homing operation (Precautions)

- In the returning operation to the home position using the controller, if the initialization signal (Z-phase signal from the encoder) is entered before the motor is not substantially decelerated (after the proximity sensor is activated), the motor may not stop at the required position. To avoid this, determine the positions with the proximity sensor on and initialization signal on in consideration of the number of pulses required for successful deceleration. The parameters for setting the acceleration/deceleration time also affect the homing operation, so that these parameters should be determined in consideration of both the positioning and homing operations.

**As for the detail of homing operation, please refer to an operation manual of controller you use. Following is one of examples.**

## Example of homing operation

The motor will start to decelerate with the proximity sensor ON, and stop with the first initialization signal (Z-phase).

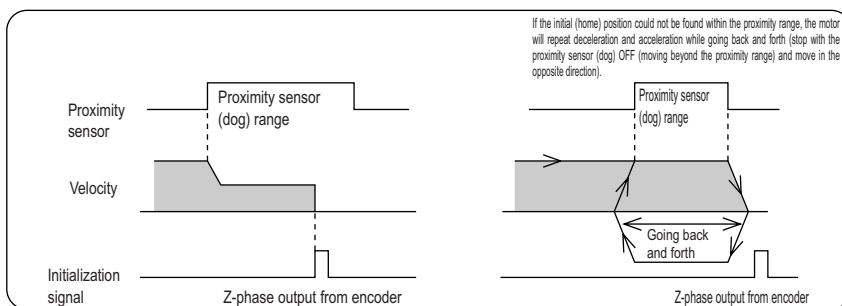

The motor will start to decelerate with the proximity sensor ON, and stop with the first initialization Z-phase signal after the proximity sensor OFF.

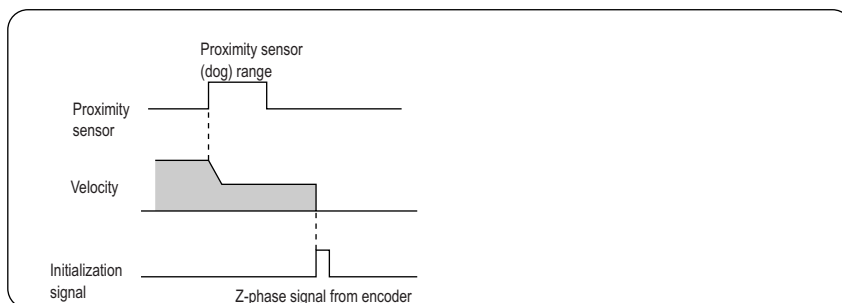

# Details of Parameters

## Parameters for Function Selection

Default setting is shown by [ ].

PrNo.	Parameter	Value	Function						
0 0	Axis address	0 ~ 15 [ 1 ]	If multiple axes are used, it is necessary for the amplifier to identify the current axis accessed by the host (e. g. PC employing RS232C). You can identify axis address by number with this parameter.						
0 2	Control mode set-up	0 ~ 1	<table border="1"> <thead> <tr> <th>Value</th> <th>Control mode</th> </tr> </thead> <tbody> <tr> <td>[ 0 ]</td> <td>Position control mode</td> </tr> <tr> <td>1</td> <td>Internal velocity control mode</td> </tr> </tbody> </table>	Value	Control mode	[ 0 ]	Position control mode	1	Internal velocity control mode
			Value	Control mode					
[ 0 ]	Position control mode								
1	Internal velocity control mode								

- \* You can easily set-up the internal speed with contact inputs only.
- \* There are 4 options of internal velocity commands. Each command data can be set using Pr53 (1st speed), Pr54 (2nd speed), Pr55 (3rd speed) and Pr56 (4th speed).
- \* Internal block diagram

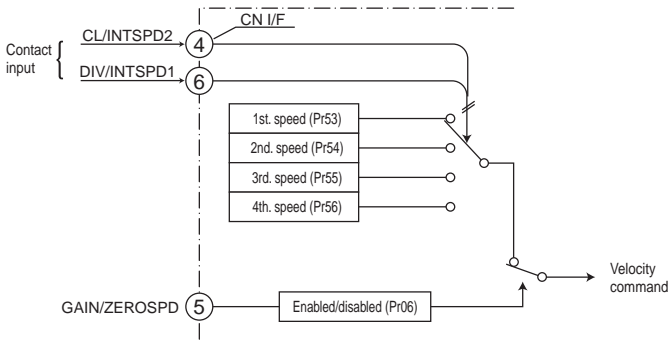

- \* Switching among 4 options of internal velocity commands can be done by 2 kinds of contact input:

- 1) DIV/INTSPD1 (CN I/F 6-pin): Internal velocity command 1
- 2) CL/INTSPD2 (CN I/F 4-pin): Internal velocity command 2

Internal speed	DIV/INTSPD1 (pin6)	INTSPD2 (pin4)
1st speed (Pr53)	OPEN	OPEN
2nd speed (Pr54)	CLOSE	OPEN
3rd speed (Pr55)	OPEN	CLOSE
4th speed (Pr56)	CLOSE	CLOSE

PrNo.	Parameter	Value	Function
0 2 (continued)	Control mode set-up (continued)		
<p data-bbox="235 327 1002 359">* Example of 4 speeds operation using internal velocity command</p> <p data-bbox="235 383 1002 470">In addition to DIV/INTSPD1 and CL/INTSPD2, zero speed clamp input (ZEROSPD) and Servo-On input (SRV-ON) are required as the input to control start and stop of the motor.</p> <div data-bbox="235 502 1002 869"> <p>The diagram illustrates the timing of a 4-speed motor operation. It features four digital input signals and a velocity-time graph. The SRV-ON input is active (high) during the 'Operation' phase. The ZEROSPD input is active (low) during 'Stop' and high during 'Operation'. The DIV/INTSPD1 input is used to select between speeds: it is 'OPEN' for the first two speeds and 'CLOSE' for the last two. The CL/INTSPD2 input is 'OPEN' for the first two speeds and 'CLOSE' for the last two. The velocity graph shows the motor accelerating to each speed level, maintaining it, and then decelerating to the next level. The 2nd and 3rd speed levels are circled in the original image.</p> </div> <p data-bbox="235 877 336 901">&lt;Notes&gt;</p> <p data-bbox="235 917 1002 965">Acceleration time, deceleration time and S-shaped acceleration/ deceleration time can be set individually.</p> <p data-bbox="235 973 560 997">Refer to the descriptions of</p> <p data-bbox="235 1005 604 1029">Pr58: Acceleration time set-up</p> <p data-bbox="235 1037 604 1061">Pr59: Deceleration time set-up</p> <p data-bbox="235 1069 879 1093">Pr5A: S-shaped acceleration/deceleration time set-up</p>			

# Details of Parameters

Default setting is shown by [ ].

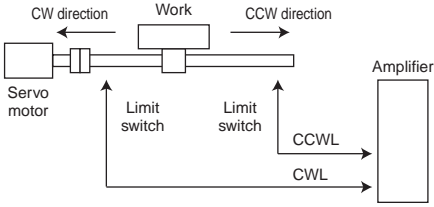
PrNo.	Parameter	Value	Function																						
0 4	Overtravel input inhibit	0 ~ 1	<p>For linear motion or other similar motion, overtraveling of the work may cause mechanical damages. To avoid this, it is necessary to provide limit switches at each end so that traveling over the limit switch position can be inhibited.</p> 																						
			<table border="1"> <thead> <tr> <th>Value</th> <th>CCWL/CWL input</th> <th>Input</th> <th>Connection to COM-</th> <th>Operation</th> </tr> </thead> <tbody> <tr> <td rowspan="4">0</td> <td rowspan="4">Enabled</td> <td rowspan="2">CCWL (CN I/F-8-pin)</td> <td>Close</td> <td>Normal with the CCW limit switch not activated</td> </tr> <tr> <td>Open</td> <td>Traveling in CCW direction inhibited</td> </tr> <tr> <td rowspan="2">CWL (CN I/F-7-pin)</td> <td>Close</td> <td>Normal with the CW limit switch not activated</td> </tr> <tr> <td>Open</td> <td>Traveling in CW direction inhibited</td> </tr> <tr> <td>[ 1 ]</td> <td>Disabled</td> <td colspan="3">Both the CCWL and CWL inputs are disabled, and traveling in both the CW and CCW directions are allowed.</td> </tr> </tbody> </table> <p>&lt;Notes&gt;</p> <ol style="list-style-type: none"> <li>With Pr04 = 0 and CCW/CW off (not connected to COM-), the amplifier will stop the motor with "overtravel limit input error" assuming that traveling over the limit occurs in both the CCW and CW directions.</li> <li>You can specify whether or not to use the dynamic brake during deceleration after CCW or CW overtravel limit input (CCWL or CWL) becomes active. For details, see the description of Pr66 (DB inhibition at overtravel limit).</li> </ol>	Value	CCWL/CWL input	Input	Connection to COM-	Operation	0	Enabled	CCWL (CN I/F-8-pin)	Close	Normal with the CCW limit switch not activated	Open	Traveling in CCW direction inhibited	CWL (CN I/F-7-pin)	Close	Normal with the CW limit switch not activated	Open	Traveling in CW direction inhibited	[ 1 ]	Disabled	Both the CCWL and CWL inputs are disabled, and traveling in both the CW and CCW directions are allowed.		
Value	CCWL/CWL input	Input	Connection to COM-	Operation																					
0	Enabled	CCWL (CN I/F-8-pin)	Close	Normal with the CCW limit switch not activated																					
			Open	Traveling in CCW direction inhibited																					
		CWL (CN I/F-7-pin)	Close	Normal with the CW limit switch not activated																					
			Open	Traveling in CW direction inhibited																					
[ 1 ]	Disabled	Both the CCWL and CWL inputs are disabled, and traveling in both the CW and CCW directions are allowed.																							

PrNo.	Parameter	Value	Function	
0 6	ZEROSPD input selection	0 ~ 1	You can switch whether to enable or disable the zero speed clamp input (ZEROSPD, CN I/F Pin 5).	
		Value	Function of ZEROSPD input (Pin 5)	
		0	The ZEROSPD input is disabled, and the amplifier assumes that the motor is always "not clamped to zero speed".	
		[ 1 ]	The ZEROSPD input is enabled, and the velocity command is regarded as "0", by opening the connection to COM- .	
0 7	Speed monitor(SP) selection	0 ~ 9	You can select/set-up the relationship between the voltage to be fed-out to the speed monitor signal output (SP: CN MON 1 Pin) and the actual speed (or command velocity) of the motor.	
		Value	SP signal	Relationship between output voltage level and velocity
		0	Actual motor speed	6V / 47 r/min
		1		6V / 187 r/min
		2		6V / 750 r/min
		[ 3 ]		6V / 3000 r/min
		4		1.5V / 3000 r/min
		5	Commanded velocity	6V / 47 r/min
		6		6V / 187 r/min
		7		6V / 750 r/min
		8		6V / 3000 r/min
		9		1.5V / 3000 r/min
0 8	Torque monitor (IM)selection	0 ~ 5	You can select/set-up the relationship between the voltage to be fed-out to torque monitor signal output (IM: CN MON 2 Pin) and the actual torque of the motor or position error pulse counts.	
		Value	IM signal	Relationship between output voltage and torque or position error pulse counts
		[ 0 ]	Torque	3V / rated torque (100%)
		1	Position error pulse counts	3V / 31 Pulse
		2		3V / 125 Pulse
		3		3V / 500 Pulse
		4		3V / 2000 Pulse
		5		3V / 8000 Pulse

# Details of Parameters

PrNo.	Parameter	Value	Function		
0 9	Warning output selection	0 ~ 5	You can define the function of warning output (WARN: CN I/F 12-pin).		
			Varue	Function	Remarks
			0	Torque in-limit	
			1	Zero speed detection	
			[ 2 ]	Alarm signal	
			3	Overregeneration alarm	
			4	Overload alarm	
5	Does not function, although displayed.				
0 C	Baud rate set-up of RS232C	0 ~ 2	Value	Baud rate	
			0	2400bps	
			1	4800bps	
			[ 2 ]	9600bps	

## Parameters for Time Constants of Gains and Filters: Related to Real Time Auto Tuning

PrNo.	Parameter	Value	Unit	Function
1 0	1st position loop gain	10 ~ 2000 [ 50 ]	1 / s	<ul style="list-style-type: none"> <li>You can define the response characteristics of position control. Higher the gain you set, quicker the in-position time you can obtain.</li> </ul>
1 1	1st velocity loop gain	1 ~ 3500 [ 100 ]	Hz *	<ul style="list-style-type: none"> <li>To obtain the overall response of the servo system together with the above position gain, set this gain as large as possible.</li> <li>* If Pr20 (inertia ratio) has been set correctly, the unit of values of Pr11 and Pr 19 is Hz.</li> </ul>
1 2	1st velocity loop integration time constant	1 ~ 1000 [ 50 ]	m s	<ul style="list-style-type: none"> <li>Integration element of the velocity loop. The smaller the setting, the quicker you can reduce the velocity error to 0.</li> <li>The integration is disabled by setting this at 1,000.</li> </ul>
1 3	1st speed detection filter	0 ~ 5 [ 4 ]	-----	<ul style="list-style-type: none"> <li>You can set-up the time constant of low-pass filter(LPF) in 6 stages(0 to 5), which is inserted after the block , and which converts the encoder signal to the velocity signal.</li> <li>Normally, use the default (4).</li> <li>If set value is smaller, the motor noise increases. But, the time constant becomes smaller and also the phase lag becomes smaller. Thus, you can set-up larger. Sudden setting of small value may cause oscillation to damage machine. Be careful in setting.</li> </ul>
1 4	1st torque filter time constant	0 ~ 2500 [ 50 ]	0.01ms	<ul style="list-style-type: none"> <li>You can set-up the time constant of the primary delay filter that is inserted to the torque command portion.</li> <li>Use this function to suppress the oscillation caused by torsion resonance.</li> </ul>
1 5	Velocity feed forward	0 ~ 100 [ 0 ]	%	<p>You can set-up the amount of velocity feed forward at position control. Position error becomes almost 0 while the motor runs at a constant speed, by setting this to 100%. The higher the setting you make, the quicker the response you can obtain with smaller position error, however, it may cause overshoot.</p>
1 6	Feed forward filter time constant	0 ~ 6400 [ 0 ]	0.01ms	<ul style="list-style-type: none"> <li>You can set-up the time constant of the primary delay filter that is inserted to the velocity feed forward portion.</li> <li>Use this function to reduce the over and undershoot of the speed, chattering of the in-position signal.</li> </ul>

# Details of Parameters

PrNo.	Parameter	Value	Unit	Function						
1 8	2nd position loop gain	0 ~ 2000 [100]	1 / s	<ul style="list-style-type: none"> <li>This amplifier provides 2(two) sets (1st. and 2nd.) of gain and time constant for position loop, velocity loop, velocity detection filter and torque command filter.</li> <li>The functions and meanings of these 2nd gains or time constants are the same as those of the 1st ones mentioned in the previous page.</li> <li>For switching between the 1st and 2nd gains or constants, see Adjustment.</li> <li>* If Pr20 (inertia ratio) has been set correctly, the unit of the values of Pr11 and Pr19 is Hz.</li> </ul>						
1 9	2nd velocity loop gain	1 ~ 3500 [100]	Hz *							
1 A	2nd velocity loop integration time constant	1 ~ 1000 [50]	m s							
1 B	2nd speed detection filter	0 ~ 5 [4]	—							
1 C	2nd torque filter time constant	0 ~ 2500 [50]	0.01ms							
1 D	Notch frequency	100 ~ 500 [1500]	Hz	<ul style="list-style-type: none"> <li>You can set-up the frequency of the resonance suppression notch filter.</li> <li>You can set-up frequency 10% lower than the resonance frequency of the machine system which you can obtain by the frequency characteristics analysis program contained in PANATERM ®.</li> <li>This notch filter function will be disabled by setting this parameter at1500.</li> </ul>						
1 E	Notch width selection	0 ~ 4 [ 2 ]	—	<ul style="list-style-type: none"> <li>You can set-up the width (five options) of the resonance suppression notch filter in 5 steps. The higher the setting is, the wider the width you can obtain.</li> <li>In normal cases, the default value should be used.</li> </ul>						
1 F	Disturbance torque observer	0 ~ 8	—	<ul style="list-style-type: none"> <li>You can set-up the time constant (eight options) of the primary delay filter inserted in the Disturbance torque observer.</li> </ul> <table border="1" style="margin-left: auto; margin-right: auto;"> <thead> <tr> <th colspan="2">Value of Pr1F</th> </tr> </thead> <tbody> <tr> <td style="text-align: center;">0 ~ 7</td> <td style="text-align: center;">[ 8 ]</td> </tr> <tr> <td>The smaller the setting is, the larger the suppression you can expect. *1</td> <td>Disturbance torque observer disabled.</td> </tr> </tbody> </table>	Value of Pr1F		0 ~ 7	[ 8 ]	The smaller the setting is, the larger the suppression you can expect. *1	Disturbance torque observer disabled.
Value of Pr1F										
0 ~ 7	[ 8 ]									
The smaller the setting is, the larger the suppression you can expect. *1	Disturbance torque observer disabled.									
<p>* 1Note that the running noise of the motor becomes larger, with a smaller value of Pr1F(better suppression of the Disturbance torque). It is recommended that you start from the larger value of Pr1F to see the actual response and decrease the value.</p> <ul style="list-style-type: none"> <li>For the calculation of Disturbance torque in the observer, the inertia ratio (Pr20) is necessary. If the load inertia is known, calculate the inertia ratio and set the value of Pr20 to the inertia ratio calculated. If the load inertia is unknown, perform the auto gain tuning so that you can automatically enter the value of Pr20.</li> </ul>										

# Parameters for real time gain tuning

Default : [ ]

PrNo.	Parameter	Value	Unit	Function		
2 0	Inertia ratio	0 ~ 10000 [100]	%	<ul style="list-style-type: none"> <li>You can set-up the ratio of load inertia to the motor's rotor inertia.</li> </ul> <div style="border: 1px solid black; padding: 5px; margin: 5px 0;"> <math display="block">\text{Pr20} = (\text{Load inertia}) / (\text{Rotor inertia}) \times 100\%</math> </div> <ul style="list-style-type: none"> <li>Set values change by operating gain adjustment rotary switch GAIN. (See page 58.)</li> <li>The load inertia can be estimated by executing the auto gain tuning, and this result will be reflected in this parameter. If Pr20 (inertia ratio) is set correctly, the unit of the values of Pr11 and Pr19 becomes Hz. If the value of Pr20 is larger than the actual load inertia, the unit of the value of these parameters becomes larger. If the value of Pr20 is smaller than the actual load inertia, the unit of the value of these parameters becomes smaller.</li> </ul>		
2 1	Real time auto tuning set-up	0 ~ 3	—	<ul style="list-style-type: none"> <li>You can define the operating mode of the real time auto tuning.</li> </ul>		
		Value	Real time auto tuning	Fluctuation of load inertia during operation		
		[ 0 ]	Not used	-----		
		1	Used	Rarely fluctuates		
		2		Fluctuates slowly		
3	Fluctuates quickly					
			<ul style="list-style-type: none"> <li>With a larger value of Pr21, a quicker response to the change of load inertia can be obtained, though the operation may become unstable depending on the operating pattern. In normal cases, the value of this parameter should be 1 or 2.</li> </ul>			
2 2	Machine stiffness at Real time auto tuning	0 ~ 9 [ 2 ]	—	<ul style="list-style-type: none"> <li>You can set-up the machine stiffness (from 10 options) that is used at the real time auto gain tuning.</li> </ul> <div style="border: 1px solid black; padding: 5px; margin: 5px 0;"> <p style="text-align: center;">Low ← Machine stiffness → High</p> <p style="text-align: center;">Low ← Servo gain → High</p> <table border="1" style="margin: 0 auto;"> <tr> <td style="padding: 2px;">Pr22</td> <td style="padding: 2px;">0 • 1-----8 • 9</td> </tr> </table> <p style="text-align: center;">Low ← Response → High</p> </div> <ul style="list-style-type: none"> <li>Large impact shock might be given to the machine, when you suddenly set this parameter to a larger value. Start from the smaller value while monitoring the machine movement.</li> </ul>	Pr22	0 • 1-----8 • 9
Pr22	0 • 1-----8 • 9					

# Details of Parameters

## Parameters for Switching to 2nd Gains

Default : [ ]

PrNo.	Parameter description	Range	Unit	Function																				
3 0	2nd gain action set-up	0 ~ 1	----	<p>• You can select the switching between PI and P action or switching between the 1st and 2nd gains.</p> <table border="1"> <thead> <tr> <th>Value</th> <th>Gain selection and switching</th> </tr> </thead> <tbody> <tr> <td>[ 0 ]</td> <td>Fixed to the 1st gains *1 (switching between PI and P possible)</td> </tr> <tr> <td>1</td> <td>Switching between the 1st and 2nd gains possible *2</td> </tr> </tbody> </table> <p>*1 Switch the PI and P action with the gain switching input (GAIN: CN I/F Pin 5).</p> <table border="1"> <thead> <tr> <th>GAIN input</th> <th>Operation of the position loop</th> </tr> </thead> <tbody> <tr> <td>COM- disconnected</td> <td>PI operation</td> </tr> <tr> <td>COM- connected</td> <td>P operation</td> </tr> </tbody> </table> <p>*2 See Adjustment for the conditions for switching between the 1st and 2nd gains.</p>	Value	Gain selection and switching	[ 0 ]	Fixed to the 1st gains *1 (switching between PI and P possible)	1	Switching between the 1st and 2nd gains possible *2	GAIN input	Operation of the position loop	COM- disconnected	PI operation	COM- connected	P operation								
Value	Gain selection and switching																							
[ 0 ]	Fixed to the 1st gains *1 (switching between PI and P possible)																							
1	Switching between the 1st and 2nd gains possible *2																							
GAIN input	Operation of the position loop																							
COM- disconnected	PI operation																							
COM- connected	P operation																							
3 1	Position control switching mode	0 ~ 8	---	<p>• You can select the conditions for switching between the 1st and 2nd gains at the position control mode.</p> <table border="1"> <thead> <tr> <th>Value</th> <th>Conditions for gain switching</th> </tr> </thead> <tbody> <tr> <td>[ 0 ]</td> <td>Fixed to the 1st gain</td> </tr> <tr> <td>1</td> <td>Fixed to the 2nd gain</td> </tr> <tr> <td>2</td> <td>2nd gain selection with the gain switching input (GAIN) ON/ (Pr30 must be set to 1)</td> </tr> <tr> <td>3 *3</td> <td>2nd gain selection with a larger torque command change</td> </tr> <tr> <td>4 *3</td> <td>Fixed to the 1st gain</td> </tr> <tr> <td>5 *3</td> <td>2nd gain selection with a larger velocity command</td> </tr> <tr> <td>6 *3</td> <td>2nd gain selection with a larger position error</td> </tr> <tr> <td>7 *3</td> <td>2nd gain selection with the position command issued 2nd gain selection with existence of 1 or more command pulse in 166 É s area.</td> </tr> <tr> <td>8 *3</td> <td>2nd gain selection with no in-position 2nd gain selection with a position error counter value larger than Pr60 (in-position detection range)</td> </tr> </tbody> </table> <p>*3 For the switching level and timing, see App. 54 and App. 55.</p>	Value	Conditions for gain switching	[ 0 ]	Fixed to the 1st gain	1	Fixed to the 2nd gain	2	2nd gain selection with the gain switching input (GAIN) ON/ (Pr30 must be set to 1)	3 *3	2nd gain selection with a larger torque command change	4 *3	Fixed to the 1st gain	5 *3	2nd gain selection with a larger velocity command	6 *3	2nd gain selection with a larger position error	7 *3	2nd gain selection with the position command issued 2nd gain selection with existence of 1 or more command pulse in 166 É s area.	8 *3	2nd gain selection with no in-position 2nd gain selection with a position error counter value larger than Pr60 (in-position detection range)
Value	Conditions for gain switching																							
[ 0 ]	Fixed to the 1st gain																							
1	Fixed to the 2nd gain																							
2	2nd gain selection with the gain switching input (GAIN) ON/ (Pr30 must be set to 1)																							
3 *3	2nd gain selection with a larger torque command change																							
4 *3	Fixed to the 1st gain																							
5 *3	2nd gain selection with a larger velocity command																							
6 *3	2nd gain selection with a larger position error																							
7 *3	2nd gain selection with the position command issued 2nd gain selection with existence of 1 or more command pulse in 166 É s area.																							
8 *3	2nd gain selection with no in-position 2nd gain selection with a position error counter value larger than Pr60 (in-position detection range)																							

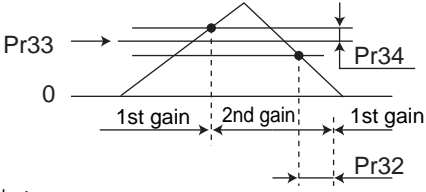
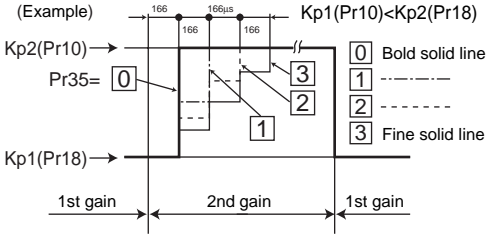
PrNo.	Parameter description	Range	Unit	Function
3 2	Position control switching delay time	0 ~ 10000 [ 0 ]	x 166 $\mu$ s	<ul style="list-style-type: none"> <li>You can set-up the delay time when switching from the 2nd. to the 1st. gain when the actual status shifts out of the preset condition with Pr31.</li> </ul>
3 3	Position control switching level	0 ~ 10000 [ 0 ]	----	<ul style="list-style-type: none"> <li>This parameter is enabled when Pr31 is set to 3,5 and 6, and you can define the level of judgement for switch from the 1st. to the 2nd. gain.</li> </ul>
3 4	Position control switching hysteresis	0 ~ 10000 [ 0 ]	----	<ul style="list-style-type: none"> <li>You can set-up the width of the hysteresis to be defined at the top and bottom of the level of judgement set with Pr33.</li> </ul> <p>The figure below shows the definitions of Pr32 (delay time), Pr33 (switching level) and Pr34 (hysteresis).</p>  <p>&lt;Notes&gt; The settings of Pr33 (level) and Pr34 (hysteresis) are enabled as absolute values.</p>
3 5	Position loop gain switching time	0 ~ 10000 [ 0 ]	(Value+1) x 166 $\mu$ s	<ul style="list-style-type: none"> <li>You can set-up a phased switching time of the gain applied to the position loop alone, while the 2nd. gain switching function is enabled.</li> </ul> <p>(Example)</p>  <p><math>Kp1(Pr10) &lt; Kp2(Pr18)</math></p> <ul style="list-style-type: none"> <li>Use this parameter only for switching from a smaller position loop gain to a larger position loop gain (from Kp1 to Kp2) (in order to reduce the impact forces caused by a large change in gain).</li> <li>Set the smaller value than the difference between <ul style="list-style-type: none"> <li>Kp2 and Kp1.</li> </ul> </li> </ul>

# Details of Parameters

## Parameters for Position Control

Default : [ ]

PrNo.	Parameter description	Range	Function																				
4 0	Command pulse multiplier set-up	1 ~ 4	<p>You can set-up the multiplication when [quadrature pulse input] is selected with Pr42(Command pulse input mode set-up).</p> <table border="1"> <thead> <tr> <th>Value</th> <th>Multiplication at quadrature pulse input</th> </tr> </thead> <tbody> <tr> <td>1</td> <td>x 1</td> </tr> <tr> <td>2</td> <td>x 2</td> </tr> <tr> <td>3 or [4]</td> <td>x 4</td> </tr> </tbody> </table>	Value	Multiplication at quadrature pulse input	1	x 1	2	x 2	3 or [4]	x 4												
Value	Multiplication at quadrature pulse input																						
1	x 1																						
2	x 2																						
3 or [4]	x 4																						
4 1	Command pulse logic inversion	0 ~ 3	<p>You can individually set-up the logic of 2-series of pulse command inputs (PULSE and SIGN).</p> <table border="1"> <thead> <tr> <th>Value</th> <th>Logic of PULSE signal</th> <th>Logic of SIGN signal</th> </tr> </thead> <tbody> <tr> <td>[0]</td> <td>Non-inversion</td> <td>Non-inversion</td> </tr> <tr> <td>1</td> <td>Inversion</td> <td>Non-inversion</td> </tr> <tr> <td>2</td> <td>Non-inversion</td> <td>Inversion</td> </tr> <tr> <td>3</td> <td>Inversion</td> <td>Inversion</td> </tr> </tbody> </table>	Value	Logic of PULSE signal	Logic of SIGN signal	[0]	Non-inversion	Non-inversion	1	Inversion	Non-inversion	2	Non-inversion	Inversion	3	Inversion	Inversion					
Value	Logic of PULSE signal	Logic of SIGN signal																					
[0]	Non-inversion	Non-inversion																					
1	Inversion	Non-inversion																					
2	Non-inversion	Inversion																					
3	Inversion	Inversion																					
4 2	Command pulse input mode set-up	0 ~ 3	<p>You can set-up the type of command pulse to be given to the amplifier from the controller. There are three types of command pulse as shown in the table below. Select an appropriate type according to the controller.</p> <table border="1"> <thead> <tr> <th>Value</th> <th>Type of command pulse</th> <th>Signal</th> <th>CCW command</th> <th>CW command</th> </tr> </thead> <tbody> <tr> <td>0 or 2</td> <td>Quadrature pulse command mode</td> <td>           PULS            SIGN         </td> <td> <p>B-phase advances A-phase by 90 degrees</p> </td> <td> <p>B-phase delays from A-phase by 90 degrees</p> </td> </tr> <tr> <td>[1]</td> <td>CW/CCW pulse command mode</td> <td>           PULS            SIGN         </td> <td> </td> <td> </td> </tr> <tr> <td>3</td> <td>Pulse/Sign command mode</td> <td>           PULS            SIGN         </td> <td> <p>"H"</p> </td> <td> <p>"L"</p> </td> </tr> </tbody> </table>	Value	Type of command pulse	Signal	CCW command	CW command	0 or 2	Quadrature pulse command mode	PULS SIGN	<p>B-phase advances A-phase by 90 degrees</p>	<p>B-phase delays from A-phase by 90 degrees</p>	[1]	CW/CCW pulse command mode	PULS SIGN			3	Pulse/Sign command mode	PULS SIGN	<p>"H"</p>	<p>"L"</p>
Value	Type of command pulse	Signal	CCW command	CW command																			
0 or 2	Quadrature pulse command mode	PULS SIGN	<p>B-phase advances A-phase by 90 degrees</p>	<p>B-phase delays from A-phase by 90 degrees</p>																			
[1]	CW/CCW pulse command mode	PULS SIGN																					
3	Pulse/Sign command mode	PULS SIGN	<p>"H"</p>	<p>"L"</p>																			

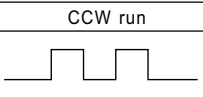
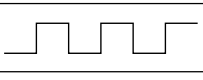
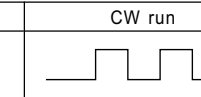
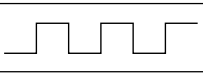
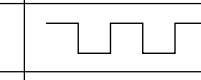
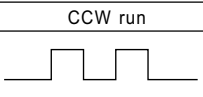
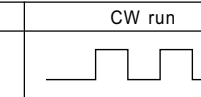
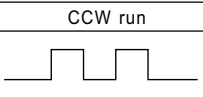
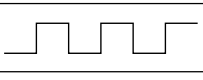
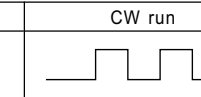
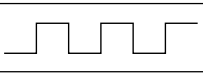
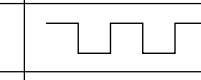
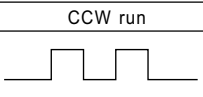
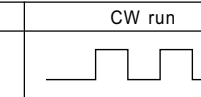
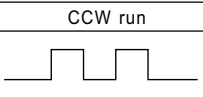
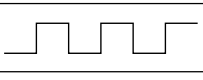
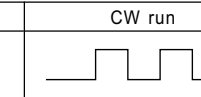
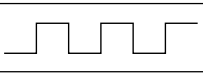
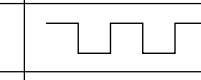
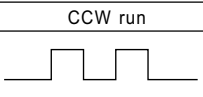
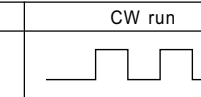
PrNo.	Parameter description	Range	Function																														
4 2 (continued)			<p>Maximum permissible frequency and minimum required time width of command pulse inputs</p> <table border="1"> <thead> <tr> <th rowspan="2">I/F for inputting PULSE/SIGN signals</th> <th rowspan="2">Maximum permissible frequency</th> <th colspan="6">Minimum required time width [ <math>\mu</math>s ]</th> </tr> <tr> <th>t<sub>1</sub></th> <th>t<sub>2</sub></th> <th>t<sub>3</sub></th> <th>t<sub>4</sub></th> <th>t<sub>5</sub></th> <th>t<sub>6</sub></th> </tr> </thead> <tbody> <tr> <td>Interface for line drivers</td> <td>500kps</td> <td>2</td> <td>1</td> <td>1</td> <td>1</td> <td>1</td> <td>1</td> </tr> <tr> <td>Interface for open collectors</td> <td>200kpps</td> <td>5</td> <td>2.5</td> <td>2.5</td> <td>2.5</td> <td>2.5</td> <td>2.5</td> </tr> </tbody> </table> <p>Make both of the rising and tailing time 0.1 <math>\mu</math>s or shorter.</p>	I/F for inputting PULSE/SIGN signals	Maximum permissible frequency	Minimum required time width [ $\mu$ s ]						t <sub>1</sub>	t <sub>2</sub>	t <sub>3</sub>	t <sub>4</sub>	t <sub>5</sub>	t <sub>6</sub>	Interface for line drivers	500kps	2	1	1	1	1	1	Interface for open collectors	200kpps	5	2.5	2.5	2.5	2.5	2.5
I/F for inputting PULSE/SIGN signals	Maximum permissible frequency	Minimum required time width [ $\mu$ s ]																															
		t <sub>1</sub>	t <sub>2</sub>	t <sub>3</sub>	t <sub>4</sub>	t <sub>5</sub>	t <sub>6</sub>																										
Interface for line drivers	500kps	2	1	1	1	1	1																										
Interface for open collectors	200kpps	5	2.5	2.5	2.5	2.5	2.5																										
4 4	Output pulses per single turn	1 ~ 16384 [2500]	You can set-up encoder pulse counts per single turn, which is to be fed-out to the controller. Setting in scalar. Set the required pulse counts per single turn in [Pulse/rev] unit directly. Note that the set-up of the larger counts than the encoder pulses is disabled.																														
4 5	Pulse output logic inversion	0 ~ 1	When the motor runs CW, the B-phase pulse delays from the A-phase pulse (when the motor runs CCW, the B-phase pulse advances the A-phase pulse).																														
			<p>You can invert the the phase relation between A and B phases by inverting the logic of the B-phase pulse with this parameter.</p> <table border="1"> <thead> <tr> <th rowspan="2">Value</th> <th rowspan="2"></th> <th>CCW run</th> <th>CW run</th> </tr> </thead> <tbody> <tr> <td></td> <td>A-phase (OA), B-phase (OB), non-inversion</td> <td></td> <td></td> </tr> <tr> <td>[0]</td> <td>B-phase (OB), non-inversion</td> <td></td> <td></td> </tr> <tr> <td>1</td> <td>B-phase (OB), inversion</td> <td></td> <td></td> </tr> </tbody> </table>	Value		CCW run	CW run		A-phase (OA), B-phase (OB), non-inversion			[0]	B-phase (OB), non-inversion			1	B-phase (OB), inversion																
Value		CCW run	CW run																														
			A-phase (OA), B-phase (OB), non-inversion																														
[0]	B-phase (OB), non-inversion																																
1	B-phase (OB), inversion																																

# Details of Parameters

Default : [ ]

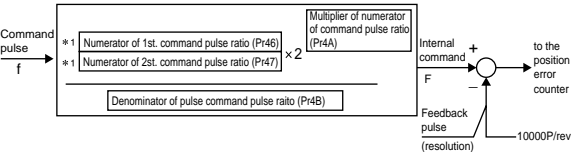
PrNo.	Parameter description	Range	Function
Parameters for Pulse Command Scaler (Pr46 through Pr4B)			
4 6	Numerator of 1st command pulse ratio	1 ~ 10000 [10000]	Pulse command scaling function (electronic gear) • Purpose 1) You can set-up any motor speed or work travel amount per input command pulse. 2) You can increase the nominal command pulse frequency with scaling, when your required speed can't be obtained due to the capacity of the pulse generator of the controller(maximum available frequency). • Block diagram of the scaling function 
4 7	Numerator of 2nd command pulse ratio	1 ~ 10000 [10000]	
4 A	Multiplier of numerator of command pulse ratio	0 ~ 17 [0]	
4 B	Denominator of command pulse ratio	1 ~ 10000 [10000]	
			• The calculated numerator is max. 2621440. Set-up of larger value than this is disabled, and automatically substituted by 2621440.

PrNo.	Parameter description	Range	Function										
46 ~ 4B (continued)			<p>You can select the numerator of the command scalar.</p> <p>*1 Select the 1st. or 2nd. numerator with scalar input switching (DIV: CN I/F Pin 6) .</p> <table border="1" data-bbox="460 304 1020 368"> <tr> <td>DIV off</td> <td>1st numerator (Pr46) selection</td> </tr> <tr> <td>DIV on</td> <td>2nd numerator (Pr47) selection</td> </tr> </table> <p>&lt;Example&gt;</p> <ul style="list-style-type: none"> <li>Basic relation is defined so as the motor runs one revolution with the command input of encoder resolution(f), when the scale ratio is 1. Therefore, when the encoder resolution is 10000 P/r, it is necessary to enter f=5000 pulses in case of scale ratio of 2, and f=40000 pulse in case of scale ratio of 1/4 to turn the motor one revolution.</li> <li>Set-up the Pr46, Pr4A and Pr4B so that the post-scaling internal command (F) equals the resolution (10000) of the encoder.</li> </ul> <div data-bbox="477 715 997 855" style="border: 1px solid black; padding: 5px;"> <math display="block">F = f \times (\text{Pr46} \times 2^{\text{Pr4A}}) / \text{Pr4B} = 10000</math> <p>F: Internal command pulse counts required for motor one revolution            f: Command pulse counts required for motor one revolution</p> </div> <table border="1" data-bbox="468 874 1020 1267"> <tr> <td>Resolution of encoder</td> <td>10000 (2500P/r x 4)</td> </tr> <tr> <td>Example 1: Command input (f) is 5000 pulses per one revolution</td> <td style="text-align: right;">           Pr 4A <input type="text" value="0"/>  <math>\frac{\text{Pr 46 } \boxed{10000} \times 2}{\text{Pr 4B } \boxed{5000}}</math> </td> </tr> <tr> <td>Example 1: Command input (f) is 40000 pulses per one revolution. However, if frequency of input pulses is 500 kpps, motor speed is 750 r/min.</td> <td style="text-align: right;">           Pr 4A <input type="text" value="0"/>  <math>\frac{\text{Pr 46 } \boxed{2500} \times 2}{\text{Pr 4B } \boxed{10000}}</math> </td> </tr> </table>	DIV off	1st numerator (Pr46) selection	DIV on	2nd numerator (Pr47) selection	Resolution of encoder	10000 (2500P/r x 4)	Example 1: Command input (f) is 5000 pulses per one revolution	Pr 4A <input type="text" value="0"/> $\frac{\text{Pr 46 } \boxed{10000} \times 2}{\text{Pr 4B } \boxed{5000}}$	Example 1: Command input (f) is 40000 pulses per one revolution. However, if frequency of input pulses is 500 kpps, motor speed is 750 r/min.	Pr 4A <input type="text" value="0"/> $\frac{\text{Pr 46 } \boxed{2500} \times 2}{\text{Pr 4B } \boxed{10000}}$
DIV off	1st numerator (Pr46) selection												
DIV on	2nd numerator (Pr47) selection												
Resolution of encoder	10000 (2500P/r x 4)												
Example 1: Command input (f) is 5000 pulses per one revolution	Pr 4A <input type="text" value="0"/> $\frac{\text{Pr 46 } \boxed{10000} \times 2}{\text{Pr 4B } \boxed{5000}}$												
Example 1: Command input (f) is 40000 pulses per one revolution. However, if frequency of input pulses is 500 kpps, motor speed is 750 r/min.	Pr 4A <input type="text" value="0"/> $\frac{\text{Pr 46 } \boxed{2500} \times 2}{\text{Pr 4B } \boxed{10000}}$												

# Details of Parameters

PrNo.	Parameter description	Range	Function										
4 C	Smoothing filter set-up	0 ~ 7	<p>This filter is a primary delay filter that is inserted after the scaling function in the command pulse input portion.</p> <div style="border: 1px solid black; padding: 5px; margin: 5px 0;"> <p>Purpose of this filter</p> <ul style="list-style-type: none"> <li>• Reduce the stepwise motion of the motor that may appear when the command input is rough.</li> <li>• The command input may become rough when:               <ol style="list-style-type: none"> <li>1) The scale ratio is large (10 times or greater)</li> <li>2) The command frequency is low.</li> </ol> </li> </ul> </div> <p>ÄEYou can set-up the time constant of the smoothing filter in 8 steps with Pr4C.</p> <table border="1" style="width: 100%; border-collapse: collapse; text-align: center;"> <thead> <tr> <th>Value</th> <th>Time constant</th> </tr> </thead> <tbody> <tr> <td>0</td> <td>No filtering function</td> </tr> <tr style="background-color: #e0e0e0;"> <td>[ 1 ]</td> <td>Small time constant</td> </tr> <tr> <td>~</td> <td>↓</td> </tr> <tr> <td>7</td> <td>Large time constant</td> </tr> </tbody> </table>	Value	Time constant	0	No filtering function	[ 1 ]	Small time constant	~	↓	7	Large time constant
Value	Time constant												
0	No filtering function												
[ 1 ]	Small time constant												
~	↓												
7	Large time constant												
4 D	Counter clear input	0 ~ 1 [ 0 ]	<p>You can set-up the conditions for clearing the position error counter, i.e. for issuing the counter clear signal (CL: CN I/F Pin 4).</p> <table border="1" style="width: 100%; border-collapse: collapse; text-align: center;"> <thead> <tr> <th>Value</th> <th>Conditions</th> </tr> </thead> <tbody> <tr style="background-color: #e0e0e0;"> <td>[ 0 ]</td> <td>Cleared with level (*1)</td> </tr> <tr> <td>1</td> <td>Cleared with edge (rising part)</td> </tr> </tbody> </table> <p>*1:Minimum time width of the CL signal</p> <div style="text-align: center; margin-top: 10px;"> <p>The diagram shows a signal labeled 'CL (pin 4)' that transitions from high to low and then back to high. A horizontal double-headed arrow below the low pulse indicates its duration, labeled 'min. 100 μs'.</p> </div>	Value	Conditions	[ 0 ]	Cleared with level (*1)	1	Cleared with edge (rising part)				
Value	Conditions												
[ 0 ]	Cleared with level (*1)												
1	Cleared with edge (rising part)												

## Parameters for Velocity Control

PrNo.	Parameter description	Range	Function				
5 3	1st internal speed	-10000 ~ 10000 [ 0 ]	<p>You can set-up the internal command velocity of 1st - 4th speed to Pr53 - 56 respectively in [r/min] unit, when the internal velocity set-up is enabled with the parameter Pr02 (Setting of Control Mode).</p> <p>&lt;Note&gt; The polarity (+/- sign) of the set values shows the polarity of internal command velocities.</p> <table border="1" style="margin: 10px auto; border-collapse: collapse;"> <tr> <td style="text-align: center; width: 30px;">+</td> <td>CCW run</td> </tr> <tr> <td style="text-align: center;">-</td> <td>CW run</td> </tr> </table> <p><b>Set up the internal command velocity within a range of the motor speed (Standard 4500/5000 (r/min) ).</b></p>	+	CCW run	-	CW run
+	CCW run						
-	CW run						
5 4	2nd internal speed	-10000 ~ 10000 [ 0 ]					
5 5	3rd internal speed	-10000 ~ 10000 [ 0 ]					
5 6	4th internal speed	-10000 ~ 10000 [ 0 ]					
5 8	Acceleration time set-up	0 ~ 5000 [ 0 ]	<p>At internal velocity control mode, you can control the time to reach the velocity you set-up, and the time to stop the motor.</p> <p>You can obtain soft-start/soft-down action of the motor when the phased velocity command is entered, or when the internal velocity set-up is selected.</p>				
5 9	Deceleration time set-up	0 ~ 5000 [ 0 ]					
			<table border="1" style="margin: 10px auto; border-collapse: collapse;"> <tr> <td style="text-align: center; width: 30px;">t a</td> <td><input style="width: 50px;" type="text" value="Pr58"/> x 2ms / 1000r/min</td> </tr> <tr> <td style="text-align: center;">t d</td> <td><input style="width: 50px;" type="text" value="Pr59"/> x 2ms / 1000r/min</td> </tr> </table>	t a	<input style="width: 50px;" type="text" value="Pr58"/> x 2ms / 1000r/min	t d	<input style="width: 50px;" type="text" value="Pr59"/> x 2ms / 1000r/min
t a	<input style="width: 50px;" type="text" value="Pr58"/> x 2ms / 1000r/min						
t d	<input style="width: 50px;" type="text" value="Pr59"/> x 2ms / 1000r/min						

# Details of Parameters

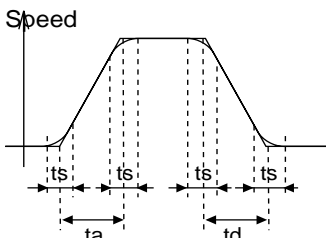
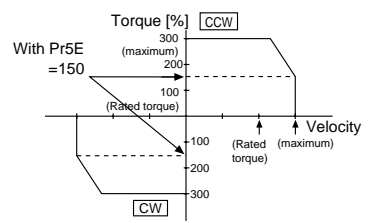
PrNo.	Parameter description	Range	Function
5 A	S-shaped accel/decel time set-up	0 ~ 500 [ 0 ]	<p>You can add a quasi S-shaped acceleration/deceleration to the velocity command, so that smooth operation can be obtained in such a case as a large impact shock will be given at starting or stopping with a linear acceleration/deceleration.</p> <div style="display: flex; justify-content: space-between;"> <div style="width: 45%;">  <p>1 Set the basic acceleration/deceleration time for the linear regions with Pr58 and Pr59.</p> <p>2 Set the time of the S-shaped portion, centering the acceleration/deceleration changing regions with Pr5A. Unit in 2 ms.</p> <p>ta : Pr58      Use at setting of <math>\frac{ta}{2} &gt; ts</math> or <math>\frac{td}{2} &gt; ts</math>.</p> <p>td : Pr59</p> <p>ts : Pr5A</p> </div> <div style="width: 45%;"></div> </div>
5 E	Torque limit set-up	0 ~ 500 [300]	<p>• You can limit the max. motor torque with this parameter.</p> <p>• In normal specifications, the amplifier can produce 300 % of the rated torque for a short duration(peak-torque). Use this limiting function when 300% torque may cause the trouble to the machine.</p> <div style="display: flex; justify-content: space-between;"> <div style="width: 45%;"> <ul style="list-style-type: none"> <li>• Set-up the value in % of the rated torque.</li> <li>• The right figure shows an example that the maximum torque is limited to 150% of the rated torque.</li> <li>• This parameter limits the maximum torque in both CW and CCW directions.</li> </ul> </div> <div style="width: 45%;">  </div> </div> <p>&lt;Notes&gt;</p> <ul style="list-style-type: none"> <li>• Pr5E "Torque limit set-up" disables set-up in excess of the values set up for the system parameter "Max. torque set-up".</li> <li>• The system parameters are fault parameters that cannot be changed with PANATERM or on the operation panel.</li> </ul>

# Sequences

Default : [ ]

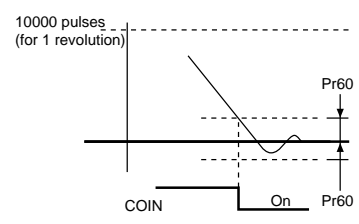
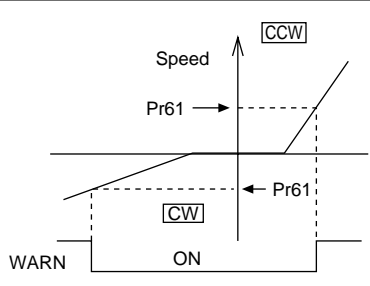
PrNo.	Parameter description	Range	Function
6 0	In-position range	0 ~ 32767 [10]	<ul style="list-style-type: none"> <li>You can set-up the output timing of the in-position signal (COIN: CN I/ F Pin 10), completing the travel of the motor (work), after the command pulse entry.</li> <li>The in-position (positioning complete) signal (COIN) will be fed-out when the position error counter pulses fall within a preset range</li> </ul>
<p>Decide the value of this parameter basing on the resolution of the en-corder, like the figure to the right.</p>  <p>&lt;Notes&gt;</p> <ol style="list-style-type: none"> <li>If you set-up too small value to Pr60, time to feed-out COIN signal gets longer, or may causes a chattering.</li> <li>The value of this parameter does not affect the accuracy in positioning.</li> </ol>			
6 1	Zero speed	0 ~ 10000 [50]	<ul style="list-style-type: none"> <li>You can set-up the output timing of the zero speed detection signal (WARN: CN I/F pin 12). Unit in [r/min].</li> <li>To enable output, Set "1" by Pr09.</li> <li>The WARN signal will be fed-out when the motor speed becomes lower than this setting.</li> </ul>
<p>Pr61 affects both CW and CCW directions regardless of the actual rotating direction.</p> 			

# Details of Parameters

PrNo.	Parameter description	Range	Function
6 2	At-speed	0 ~ 10000 [1000]	<ul style="list-style-type: none"> <li>You can set-up the output timing of at-speed signal (COIN: CN I/F 10 pin) by setting motor speed [r/min] in internal velocity control mode.</li> <li>The at-speed signal (COIN) is output, when the motor speed exceeds set value of this parameter Pr62.</li> </ul>
<p>Setting of Pr62 works in both CW/CCW directions regardless of rotational direction of motor.</p>			
6 3	Position error limit protection	0 ~ 32767 [1875]	<ul style="list-style-type: none"> <li>You can set-up the detection level for the position error limit at [Position error limit protection], with error counter pulses.</li> </ul>
<p>• Calculate the value of this parameter using the following formula.</p> <div style="border: 1px solid black; padding: 5px; width: fit-content; margin: 10px auto;"> <math display="block">\text{Parameter value} = [\text{Position error limit level (pulses)}] / 256</math> </div> <p>&lt;Note&gt; If you set the position gain to low value, and set this Pr63 value too small, the position error limit protection could be activated, even though no unusual situation is to be found.</p>			
6 4	Position error invalidation	0 ~ 1	You can disable the position error limit protection.
Value		Position error limit protection	
[ 0 ]		Enabled	
1		Disabled. The motor continues to run, even though the pulse counts exceeds the level set by Pr63, judging that no unusual situation is found.	

PrNo.	Parameter description	Range	Function																							
6 6	DB inhibition at overtravel limit	0 ~ 1	You can set-up the conditions for decelerating the motor after the over-travel limit input (CCWL: CNI/F Pin 9 or CWL: CN I/F Pin 8) is made active.																							
			Value	Motor operation from deceleration to and after stop																						
			[ 0 ]	With the dynamic brake (DB) activated the motor is stopped. After stop, the dynamic brake is released.																						
			1	Without dynamic brake the motor stops. After stop, the motor remains free.																						
6 8	Sequence at alarm	0 ~ 3	Defines the conditions for decelerating the motor and keeping the motor stopped after one of the amplifier's protective functions (alarms) is activated.																							
			Value	<table border="1"> <thead> <tr> <th rowspan="2">Value</th> <th colspan="2">Operating conditions</th> <th rowspan="2">Position error counter</th> </tr> <tr> <th>During deceleration</th> <th>After stop</th> </tr> </thead> <tbody> <tr> <td>[ 0 ]</td> <td>DB</td> <td>DB</td> <td>Cleared</td> </tr> <tr> <td>1</td> <td>Free run</td> <td>DB</td> <td>↑</td> </tr> <tr> <td>2</td> <td>DB</td> <td>Free run</td> <td>↑</td> </tr> <tr> <td>3</td> <td>Free run</td> <td>Free run</td> <td>↑</td> </tr> </tbody> </table>	Value	Operating conditions		Position error counter	During deceleration	After stop	[ 0 ]	DB	DB	Cleared	1	Free run	DB	↑	2	DB	Free run	↑	3	Free run	Free run	↑
			Value	Operating conditions		Position error counter																				
				During deceleration	After stop																					
			[ 0 ]	DB	DB	Cleared																				
			1	Free run	DB	↑																				
			2	DB	Free run	↑																				
			3	Free run	Free run	↑																				
(DB: Dynamic brake activated)																										
See also "Timing chart for alarms" in Appendix 11.																										
6 9	Sequence at servo-off	0 ~ [ 0 ]	Defines the following processes after Servo-OFF (SER-ON signal: CN I/F Pin 2).																							
			1) Operating conditions during deceleration and after stop 2) Process for clearing the position error counter																							
			For the relations among Pr69 values, operating conditions and process for clearing the position error counter, see App.8.8.4 Dynamic brake.																							
			See also "Timing chart for Servo-ON/OFF during the halt of motor" in Appendix 12.																							

# Details of Parameters

Default: [ ]

PrNo.	Parameter description	Range	Function
6 A	Mechanical Brake action set-up at motor standstill	0 ~ 100 [ 0 ]	<p>Defines the duration from OFF of the brake release signal (BRK-OFF) (i.e. brake engaged) to the shutdown of motor current (servo free) in transition to Servo-OFF during the halt of the motor.</p> <div style="display: flex; align-items: flex-start;"> <div style="flex: 1;"> <ul style="list-style-type: none"> <li>• The value of this parameter should not be less than the value of <math>t_b</math> (delay of braking) in order to avoid the minute movement or fall of the motor (work).</li> <li>• <math>Pr6A = (Entry) \times 2 \text{ ms}</math></li> <li>• See also "Timing chart for Servo-ON/OFF during the halt of motor" in Appendix 12.</li> </ul> </div> <div style="flex: 2;"> <p>The timing chart for parameter 6A shows four signals over time. SRV-ON transitions from On to Off. BRK-OFF transitions from Brake released to Brake engaged. Actual braking transitions from Brake released to Brake engaged. Motor current transitions from Energized to Not energized. A horizontal arrow labeled <math>t_b</math> indicates the delay from the start of the BRK-OFF transition to the start of the Actual braking transition. Another horizontal arrow labeled Pr6A indicates the duration from the end of the BRK-OFF transition to the end of the Motor current transition.</p> </div> </div>
6 B	Mechanical brake action set-up at motor in motion	0 ~ 100 [ 0 ]	<p>Defines the duration from the shutdown of motor current (servo free) to OFF (i.e. brake engaged) of the brake release signal (BRK-OFF) in transition to Servo-OFF during the motor in motion, not during the halt as handled by Pr6A.</p> <div style="display: flex; align-items: flex-start;"> <div style="flex: 1;"> <ul style="list-style-type: none"> <li>• This parameter is necessary for avoiding the degradation of the brake due to the rotation of the motor.</li> <li>• The value of <math>T_b</math> is the value of Pr6B or the time needed for decreasing the motor speed to about 30 r/min, whichever is smaller.</li> <li>• <math>Pr6B = (Entry) \times 2 \text{ ms}</math></li> <li>• See also "Timing chart for Servo-ON/OFF during the halt of motor" in Appendix 13.</li> </ul> </div> <div style="flex: 2;"> <p>The timing chart for parameter 6B shows four signals over time. SRV-ON transitions from On to Off. BRK-OFF transitions from Brake released to Brake engaged. Motor current transitions from Energized to Not energized. Motor velocity (r/min) shows a deceleration curve. A horizontal arrow labeled <math>T_b</math> indicates the duration from the start of the Motor current transition to the start of the BRK-OFF transition. A vertical arrow points to the end of the Motor velocity curve, labeled "Approx. 30 r/min".</p> </div> </div>

PrNo.	Parameter description	Range	Function	
6 C	External regenerative discharge resistor selection	0 ~ 3	Install an external regenerative discharge resistor (between P (5-pin) and B2 (3-pin) on the relevant connector), and set this parameter as necessary.	
		Value	Regenerative discharge resistor	Over-regenerative power protection
		0	External regenerative discharge resistor DVOP2890 DVOP2890	Regenerative discharge resistor overload protection works depending on the capacity of the optional external regenerative discharge resistor.
		1	External resistor	The protection operates for the external resistor whose operating limit is 10% of the duty.
		2	External resistor  <Notes> <b>Don't fail to install external protection such as thermal fuse.</b> Otherwise, regenerative discharge resistor is not protected any more to cause possible abnormal heat generation, resulting in burning of the motor.	The protection is activated as operating limit of the external resistor and as 100% duty.
[ 3 ]	Not used.	Regeneration processing circuit is not operated.		

<Notes>

For safety, a thermal fuse is built in the optional external regenerative discharge resistor. Wiring to the internal thermal fuse may break depending on the applicable heat radiating conditions, operating temperature range, supply voltage and load fluctuation.

Be sure to assemble the amplifier with the machine and check the operating limit so that the surface temperature of the regenerative discharge resistor may be 100°C or lower on poor conditions likely to cause generation of regenerative discharge resistance conditions (such as high supply voltage, large load inertia and short deceleration time).

# Optional Parts

## MINAS-S series Cables

Fig. No.	Motor type	Cable	Part No.
2-1	MUMS30 ~ 750W	Encoder cable (2500 P/r, 11 wires), incremental encoders	MFECAO**OEAA
3-1		Motor cable	MFMCAO**OAEB
4-1		Brake cable	MFMCBO**OGET

## Encoder Relay Cables

fig2-1

MFECAO\*\*OEAA

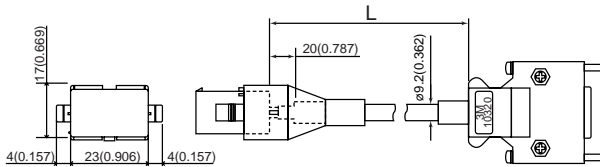

L (m)	Part No.
3	MFECAO030EAA
5	MFECAO050EAA
10	MFECAO100EAA
20	MFECAO200EAA

## Motor Relay Cables (Robotop®, 600V DP)

Robotop is the trademark of Sumitomo Denso.

fig 3-1

MFMCAO\*\*OAEB

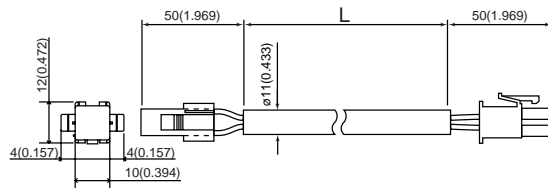

L (m)	Part No.
3	MFMCA0030AEB
5	MFMCA0050AEB
10	MFMCA0100AEB
20	MFMCA0200AEB

## Motor Brake Relay Cables (Robotop®, 600V DP)

fig 4-1

MFMCBO OGET

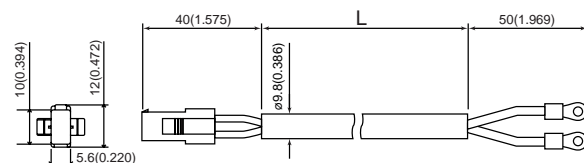

L (m)	Part No.
3	MFMCB0030GET
5	MFMCB0050GET
10	MFMCB0100GET
20	MFMCB0200GET

## Connector for Monitor

1) Part No.DV0P2880

2) Components

Item	Manufacturer's Part No.	Quantity	Manufacturer	Remarks
Connector (3P)	5 1 0 0 4 - 0 3 0 0	1	Molex	For CN MON (3 pin)
Connector pin	5 0 0 1 1 - 8 1 0 0	3	Incorporated	

3) Pin alignment of connector for CN MON

4) Recommended manual press fitting tools  
(Customers are requested to prepare these tools for themselves.)

Product No. 57032-5000 Molex Incorporated

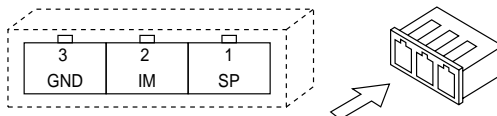

<Notes>

- The table above shows the pins alignment, looking from the connector pin inserted direction of connector. Make sure of the pin numbers marked on the plug itself for actual connection so that wiring is done correctly.
- For wiring and connection, refer to "Main circuits" in "System Configuration and Wiring" (page 22).

## Connector Kits for Power Source for Amplifier

1) Part No. DV0P2870

2) Components

Item	Manufacturer's Part No.	Quantity	Manufacturer	Remarks
Connector (10-pin)	5557-10R-210	1	Molex	POWER connector (10-pin)
Connector pin	5556PBTL	4	Incorporated	

3) Pin alignment of the connector for CN POWER connector

4) Recommended manual press fitting tools (Customers are requested to prepare these tools for themselves.)

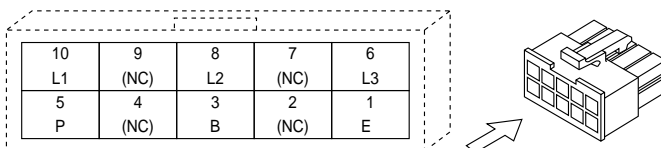

<Notes>

- The table above shows the pins alignment, looking from the terminal inserted direction of the receptacle. Make sure of the pin numbers marked on the plug itself for actual connection so that wiring is done correctly.
- For wiring and connection, refer to "Main circuits" in "System Configuration and Wiring" (page 22).
- Never connect anything to the pins where (NC) is written on the table above.

# Optional Parts

## Connector Kits for Motor and Encoder

• Used for: MUMS 30W to 750W [ with a 2500-pulse, 11-wire incremental encoder ]

- 1) Part No. DVOP2900
- 2) Components

Item	Manufacturer's Part No.	Quantity	Manufacturer	Remarks
Connector	10120-3000VE	1	SUMITOMO	For CN I/SIG
Connector Cover	10320-52A0-008	1	3 M	(20pin)
Connector(15P)	172163-1	1	Tyco Electronics	For encoder cable
Connector Pin	170365-1	15	AMP	(15 pins)
Connector(4P)	172159-1	1	Tyco Electronics	For motor cable
Connector Pin	170366-1	4	AMP	(4 pins)
Connector(6P)	5557-06R-210	1	Molex	For CN MOTOR
Connector Pin	5556PBT	4	Incorporated	(6-pin)

<Notes>

Plugs, shells and other parts may be equivalents of other manufacturer's make.

- 3) Alignment of CN SIG pins

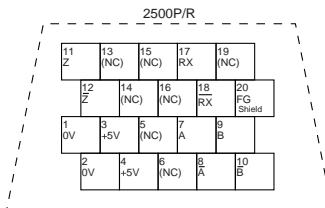

- 4) Recommended manual press fitting tools (Customers are requested to prepare these tools for themselves.)

Name	Product No.	Manufacturer	Cable Materials
For encoder cable relay	755330-1	Tyco Electronics	—
For motor power cable relay	755331-3	AMP	—
For CN MOTOR	57026-5000	Molex	UL1007
	57027-5000	Incorporated	UL1015

<Notes>

1. The tables above show the pins alignment, looking from where the plugs are soldered.
2. The pin 20 (FG) should be connected to the shield of the shielded wire. Pins marked with NC should be left unconnected.
3. For wiring and connecting, see the section "System Configuration and Wiring" on page 23.

5) Pin alignment of relay connector for encoder cable

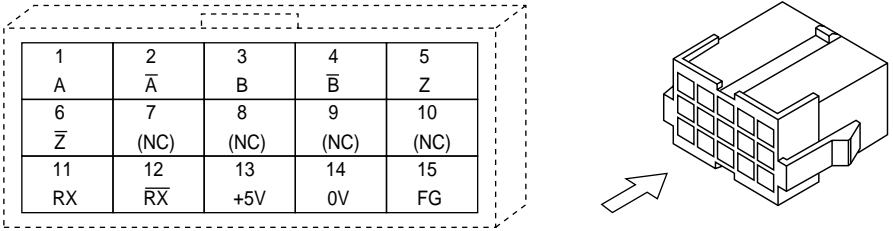

6) Pin alignment of relay connector for motor cable

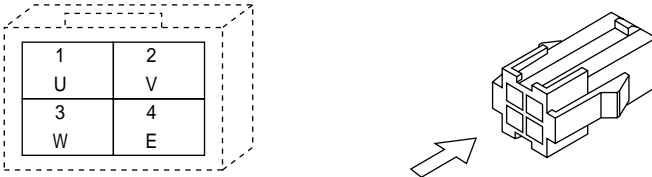

7) Pin alignment of connector for CN MOTOR

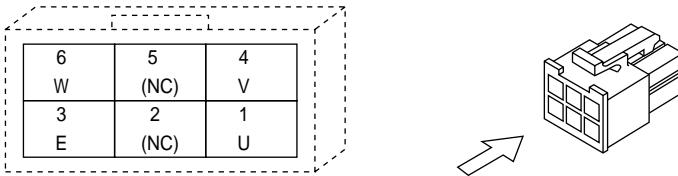

<Notes>

1. The table above shows the pins alignment, looking from the connector pin inserted direction of the connector. Make sure of the pin numbers marked on the plug for actual connection so that wiring is done correctly.
2. For wiring and connection, refer to "System Configuration and Wiring" on page 22.

# Optional Parts

## Connector Kits for Host Control Equipment

1) Part No. DV0P0770

2) Components

Item	Manufacturer's Part No.	Quantity	Manufacturer	Remarks
Connector	10126-3000VE	1	SUMITOMO	For CN I/F
Connector cover	10326-52A0-008	1	3 M	(26 pins)

3) Alignment of CN I/F (26 pins) (Looking from where the plug is soldered)

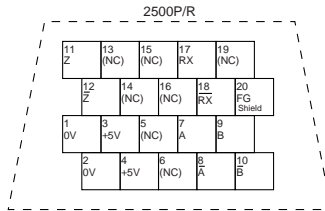

<Notes>

1. Before making connections, check the Pin Numbers stamped on the plugs.
2. For the symbols and functions of the pins, see the section "System Configuration and Wiring" on the page 26 .

## Interface Cables for controller connection

1) Part No. DVOP0800

2) Dimension

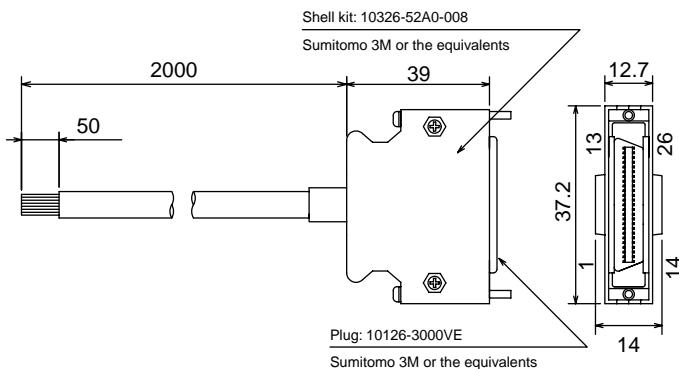

3) Wire table

Pin No.	Signal name	Wire color	Pin No.	Signal name	Wire color	Pin No.	Signal name	Wire color
1	COM+	Orange (Red 1)	1 0	COIN	Pink (Brack 1)	1 9	OZ+	Pink (Red 2)
2	SRV-ON	Orange (Brack1)	1 1	BRK-OFF	Orange (Red 2)	2 0	OZ-	Pink (Brack 2)
3	A-CLR	Gray (Red 1)	1 2	WARN	Orange (Brack 2)	2 1	CZ	Orange (Red 3)
4	CL/INTSPD2	Gray (Brack 1)	1 3	COM-	Gray (Red 2)	2 2	PLUS1	Gray (Red 3)
5	GAINZEROSPD	White (Red 1)	1 4	GND	Gray (Brack 2)	2 3	PLUS2	Gray (Brack 3)
6	DIV/INTSPD1	White (Brack 1)	1 5	OA+	White (Red 2)	2 4	SIGN1	White (Red 3)
7	CWL	Yellow (Red 1)	1 6	OA-	White (Brack 2)	2 5	SIGN2	White (Brack3)
8	CCWL	Yellow (Brack 1)	1 7	OB+	Yellow (Red 2)	2 6	FG	Orange (Brack 3)
9	ALM	Pink (Red 1)	1 8	OB-	Yellow (Brack 2)			

<Notes>

For example, Orange (Red 1) for Pin No.1 means that the lead wire is colored in orange with one dot mark in red.

# Optional Parts

## Communication Cables (for connection to personal computer)

1) Part No. DVOP1960 (for DOS/V)

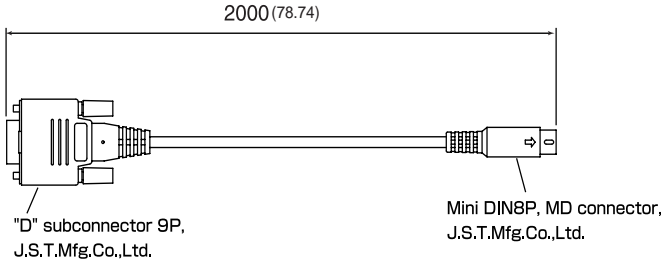

2) Part No. DVOP1160 (for PC98 series)

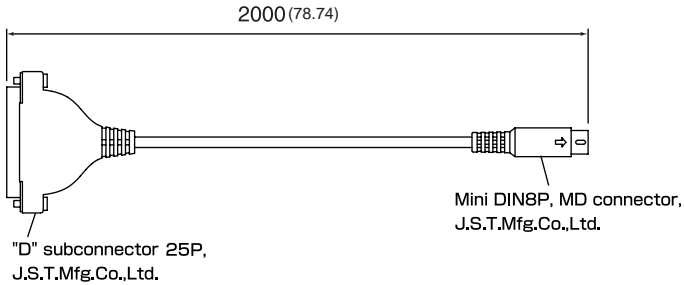

## Communication Control Software PANATERM®

1) Part No. DVOP2820 (English Version)

2) 3.5 inches Floppy Disks

<Notes>

For the operating environment and other details, see the Instructions for PANATERM®.

## External Regenerative Discharge Resistor

Part.No.	Product number	Specifications		
		Resistance	Rated power	Built-in thermal fuse operating temperature
DVOP2890	4 5 M 0 3	50 Ω	1 0 W	130 ±2 °C
DVOP2891	4 5 M 0 3	100 Ω	1 0 W	130 ±2 °C

Manufacturer: IWAKI MUSEN KENKYUSHO CO., LTD

### <Notes>

For safety, a thermal fuse is built in the optional external regenerative discharge resistor. Wiring to the internal thermal fuse may break depending on the applicable heat radiating conditions, operating temperature range, supply voltage and load fluctuation.

Be sure to assemble the amplifier with the machine and check the operating limit so that the surface temperature of the regenerative discharge resistor may be 100Åé or lower on poor conditions likely to cause generation of regenerative discharge resistance (such as high supply voltage, large load inertia and short deceleration time).

### Recommended combination between amplifier and external regenerative discharge resistor

Amplifier type	Power supply	
	Single-phase 100V	Single phase/Three-phase 200V
1	DVOP2890 x 1	DVOP2891 x 1
2		
3		

For amplifier types, see pages 10 and 11.

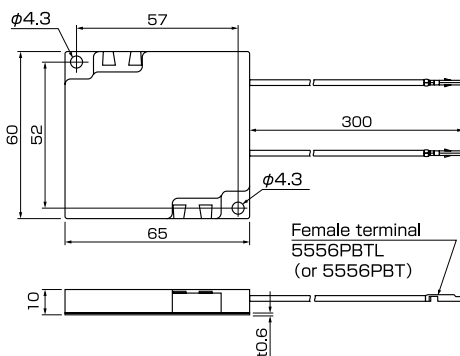

### <Notes>

Regenerative discharge resistor reaches high temperature.

Device measures to avoid fire and burns.

When mounting the amplifier, do not install near flammables.

Do not install in a place reached by hand.

# Optional Parts

## Reactor

Amplifier	Voltage	Rated output	Reactor Part No.
MUDS	Single-phase 100V	30W ~ 100W	DVOP227
		100W	
		200W ~ 400W	DVOP228
	Single-phase 200V	30W ~ 400W	DVOP220
		100W ~ 400W	
	3-phase 200V	30W ~ 400W	
		100W ~ 400W	
Single-phase 200V	400W	DVOP221	
3-phase 200V	750W		

fig. 1

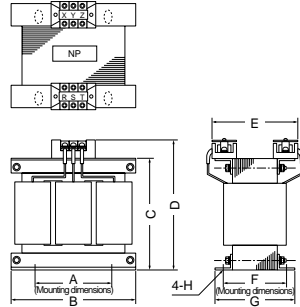
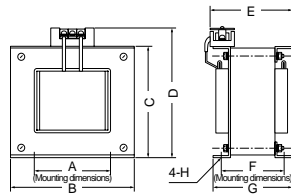

fig. 2



	Product	A	B	C	D	E	F	G	H	I	Inductance (mH)	Rated set-up (A)
fig 1	DVOP220	65	125	83	118	145	70	85	7(W) x ~12(L)	M 4	6.81	3
	DVOP221	60	150	113	137	120	60	75	7(W) x ~12(L)	M 4	4.02	5
fig 2	DVOP227	55	80	68	90	90	41	55	ø 7	M 4	4.02	5
	DVOP228	55	80	68	90	95	46	60	ø 7	M 4	2	8

# Recommended Parts

## Surge Absorber for Motor Brake

Motor	Surge absorber for brake
MUMS30W ~ 750W	<ul style="list-style-type: none"> <li>C-5A2 or Z15D151</li> </ul> Ishizuka Electronics Corporation

- Recommended parts are those specified for measurement of the brake releasing time.

## Peripheral Equipment Manufacturers

November 2000

Manufacturer/agent	Tel	Equipment
Matsushita Electric Works, Ltd.	81-06-6908-1131	Contact and surge absorber No fuse breaker
IWAKI MUSEN KENKYUSHO CO., LTD	81-044-833-4311	Regenerative discharge resistor
Ishizuka Electronics Corporation	Kantou Area 81-03-3621-2703 Chubu Area 81-052-777-5070 Kansai Area 81-06-6391-6491	Surge absorber for Brake
Hitachi Semiconductor and Devices Sales Co., Ltd.	81-06-6263-2031	Diode for brake
TDK Corporation	Kantou Area 81-03-5201-7229 Chubu Area 81-052-971-1712 Kansai Area 81-06-6245-7333	Noise filter for signal line
Okaya Electric Industries Co., Ltd.	East Japan 81-03-3424-8120 West Japan 81-06-6392-1781	Surge absorber Noise filter
Sumitomo 3M	Kantou Area 81-03-5716-7290 Chubu Area 81-052-322-9652 Kansai Area 81-06-6447-3944	Connector
Tyco Electronics AMP	Kantou Area 81-044-844-8111 Chubu Area 81-0565-29-0890 Kansai Area 81-06-6533-8232	
Molex Incorporated	Kantou Area 81-0462-65-2313 Chubu Area 81-052-571-4413 Kansai Area 81-06-6377-6760	
Sumitomo Wiring System, LTD.	81-06-6229-1960	Cable

# Dimensions

Motor

## MUMS Series 30W ~ 750W

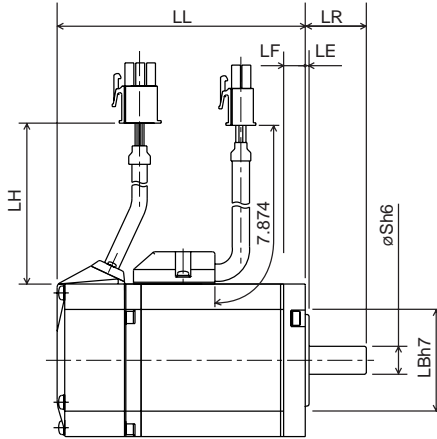

Encoder wire dimension LH      30W -100W      230 mm  
 200W -750W      220 mm

		Model	Output(W)	LL	S	LR mm(Inch)	LB	LE	LF	LH			
MUMS	Without brake	MUMS3AZA1□	3 0	2.657	0.250	24	0.866	0.079	0.276	9.055			
		MUMS5AZA1□	5 0	2.972		(0.945)							
		MUMS01□A1□	1 0 0	3.642	0.500	28.5					2.877	0.118	
		MUMS02□A1□	2 0 0	3.780									34 (1.339)
		MUMS04□A1□	4 0 0	4.862									
	MUMS082A1□	7 5 0	5.610	0.625	34 (1.339)	0.315							
	With brake	MUMS3AZA1□	3 0	3.898	0.250	24	0.866	0.079	0.276	9.055			
		MUMS5AZA1□	5 0	4.213		(0.945)							
		MUMS01□A1□	1 0 0	4.882	0.500	28.5					2.877	0.118	
		MUMS02□A1□	2 0 0	5.079									34 (1.339)
MUMS04□A1□		4 0 0	6.161										
MUMS082A1□	7 5 0	6.949	0.625	34 (1.339)	0.315								

\* LL - LH Unit Inch

Unit: mm (Inch)

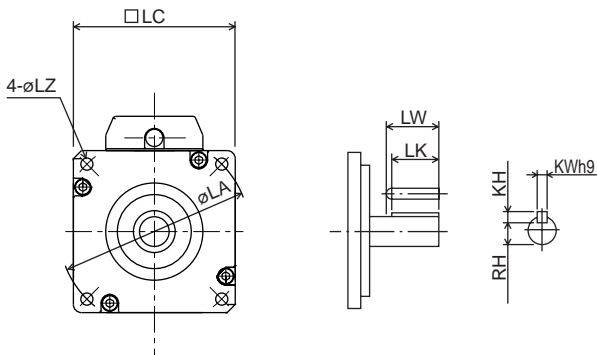

Key way type  
(Dimensions incl. key)

		LA	LC	LZ	LW	LK	KW	KH	RH	Weight(kg)
SWUMM	Without brake	1.724	1.654	M 3 Depth4.5	13	12	2	2	5.8	0.30
					14	12.5	3	3	6.2	0.40
				3.874	3.346	4.5	20	18	4	4
	25	22.5	5				5	11	1.5	
	6.5	22	6			6	15.5	3.1		
	With brake	1.724	1.654	M 3 Depth4.5	13	12	2	2	5.8	0.50
14					12.5	3	3	6.2	0.60	
3.874				3.346	4.5	20	18	4	4	8.5
	25	22.5	5			5	11	1.9		
	6.5	22	6		6	15.5	3.8			

Unit: mm

# Dimensions

Amplifier Type 1

Weight: 0.7 kg

unit: mm(Inch)

Back panel mount type  
(Standard)

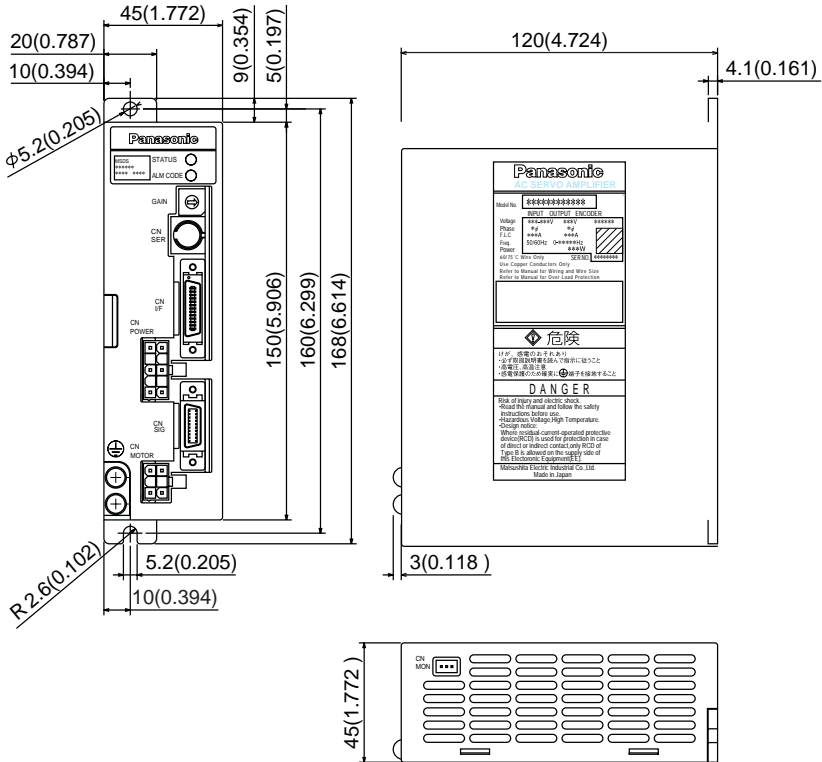

Back panel mount type  
(Standard)

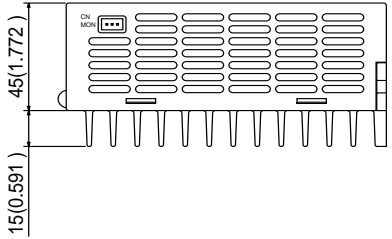
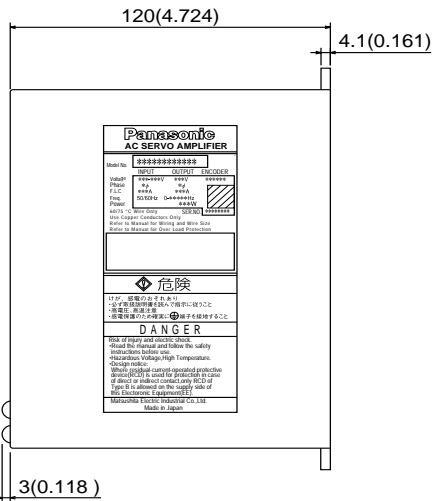
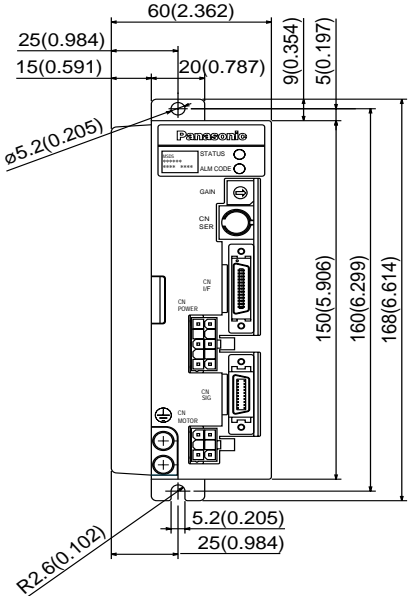

# Dimensions

Amplifier Type 3

Weight: 1.2 kg

unit: mm(Inch)

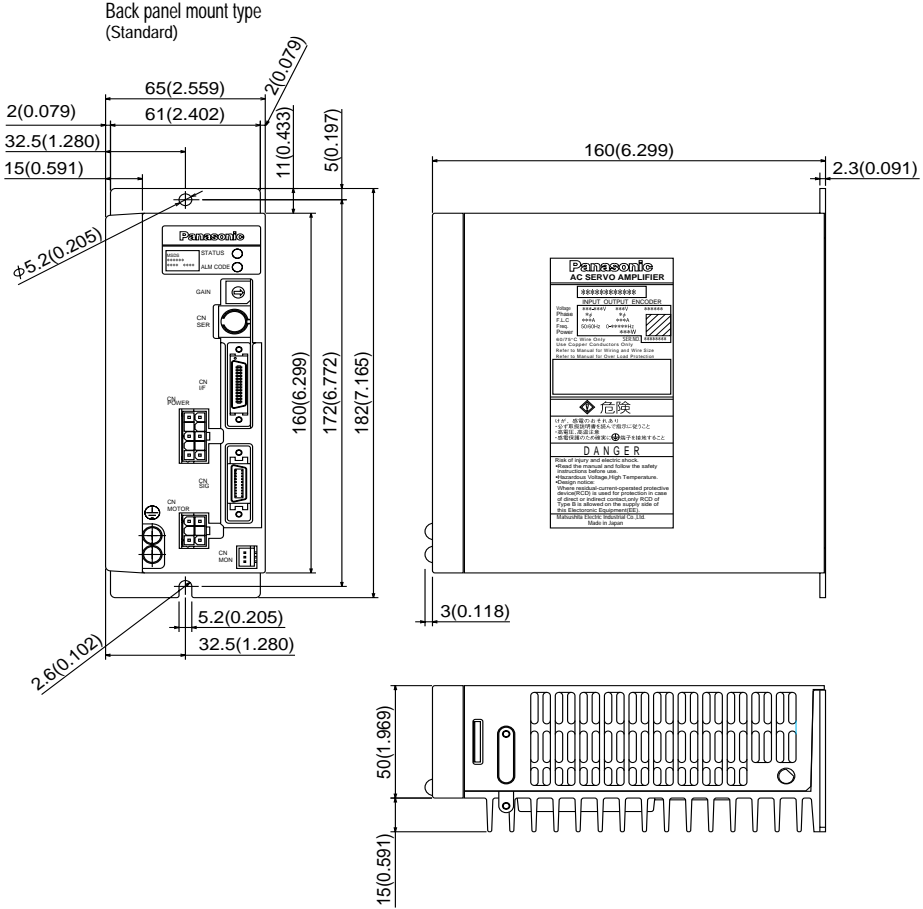

# Characteristics

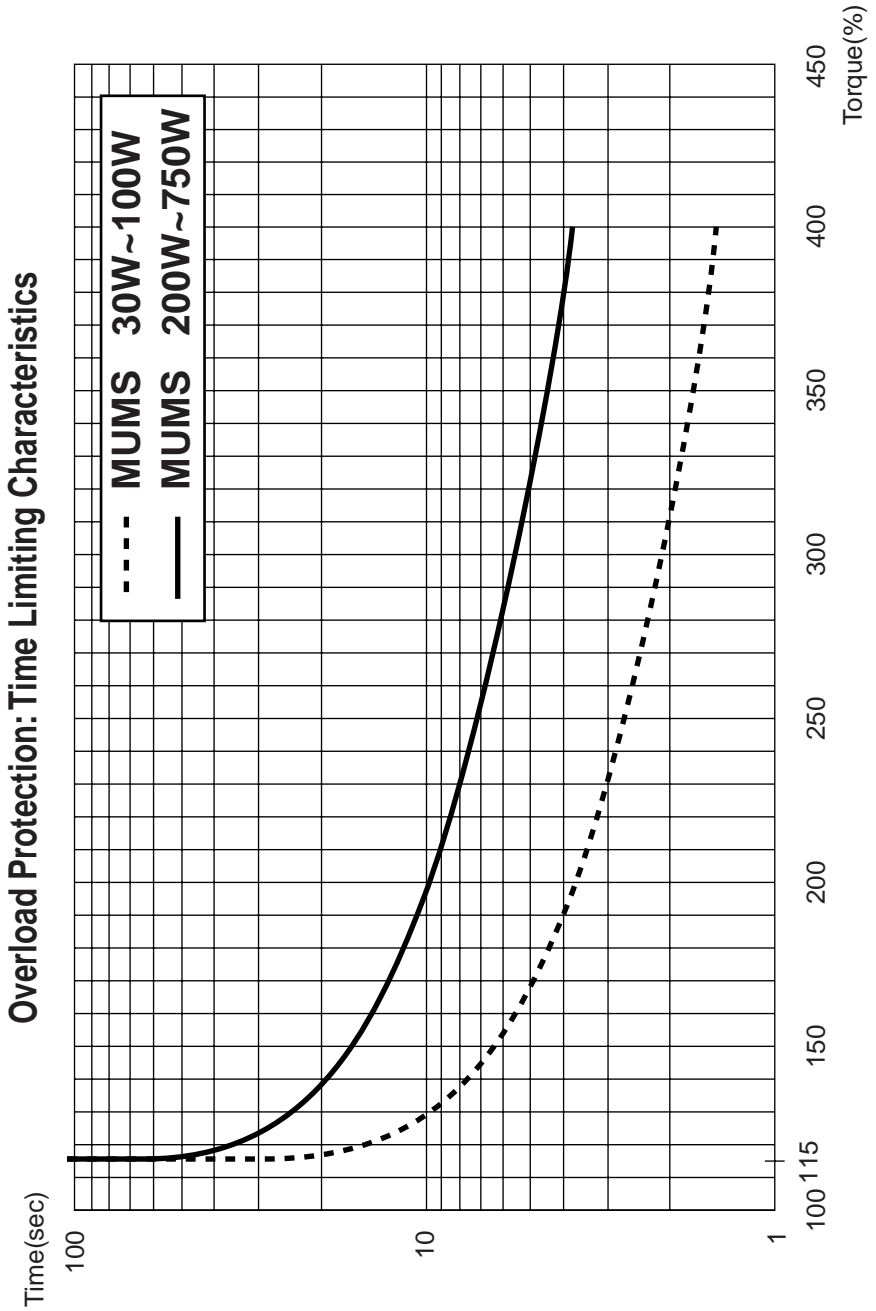

# Specifications

## Gain Switching Conditions

Position Control Mode (○: the parameter valid, -: invalid)

Gain switching conditions			Parameters for position control		
Pr31	Switching conditions	Figure	Delay time <sup>A#1</sup>	Level	Hysteresis <sup>A#2</sup>
			Pr32	Pr33	Pr34
0	Fixed to 1st gain		----	----	----
1	Fixed to 2nd gain		----	----	----
2	Gain switching input, 2nd gain selected with GAIN On		----	----	----
3	2nd gain selected with a large torque command differential	A	○	○*3 (0.05%/166 μs)	○*3 (0.05%/166 μs)
4	Fixed to 1st gain		----	----	----
5	Large target velocity commanded	B	○	○ (r/min)	○ (r/min)
6	Large position error	C	○	○*4 (pulse)	○*4 (pulse)
7	Position command existing	D	○	----	----
8	Positioning incomplete	E	○	----	----

\*1 Delay time (parameters Pr32) becomes effective when returning from 2nd gain to 1st gain.

\*2 For the definitions of hysteresis parameters (Pr34), see the right figure.

\*3 When conditions are that torque fluctuation of 10% was experienced in the 166 É s area, set up the value 200.

$$10\%/166 \text{ É s} = \text{Set-up value [200]} \times (0.05\%/166 \mu\text{s})$$

\*4 Resolution of encoder

· Figures A through E are shown in the next page.

● Internal velocity control mode

Gain switching is disabled(fixed to 1<sup>st</sup> gain).

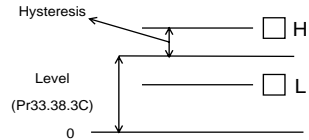

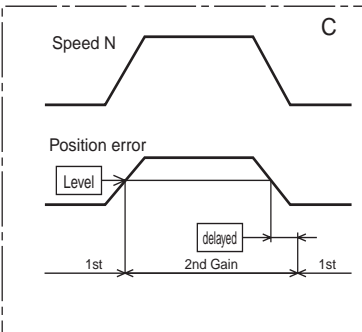
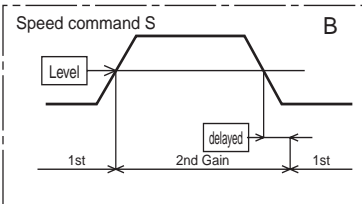
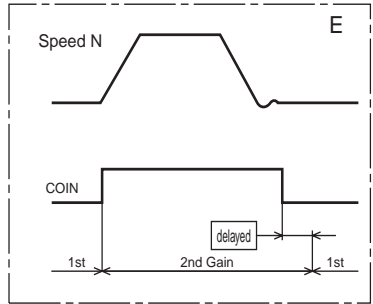
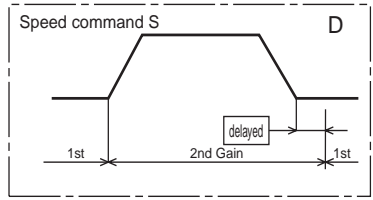
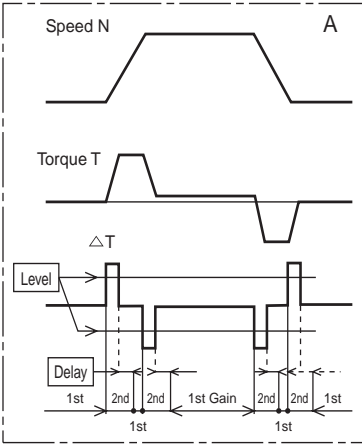

<Notes>

The figures above do not reflect the gain switching timing delay caused by hysteresis ( Pr34) .

# Specifications

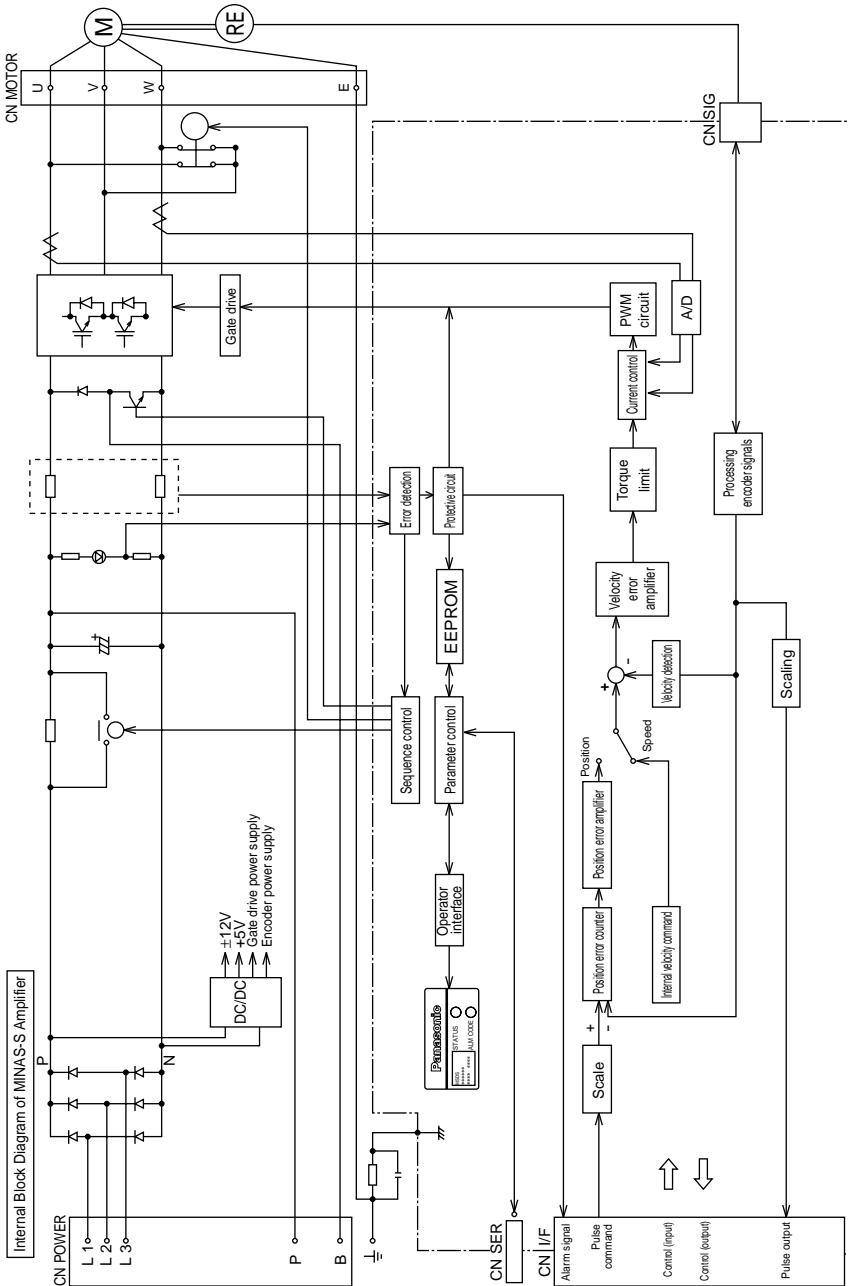

## • Control Block Diagram

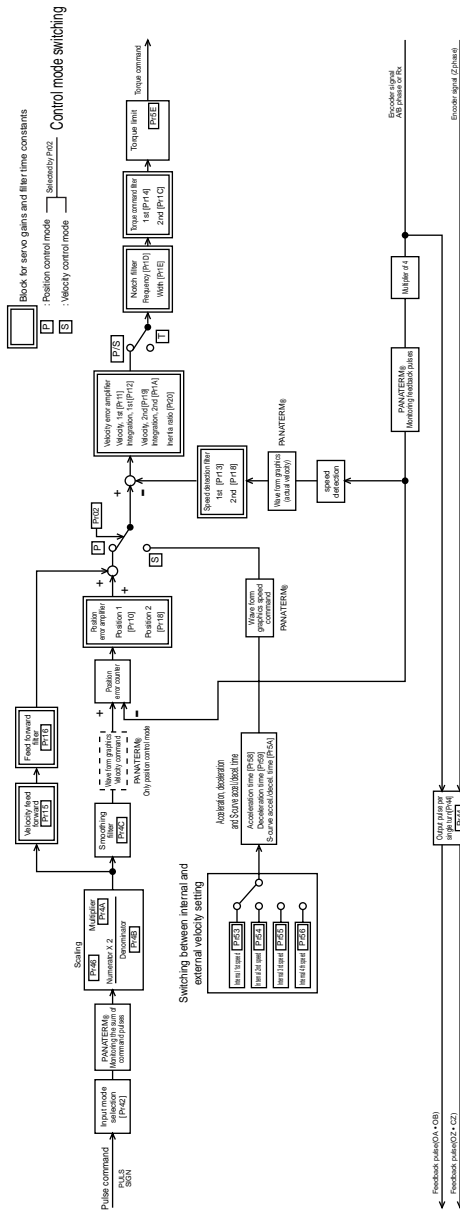

# Specifications

Amplifier	Power	Single-phase 100V system		Single-phase, AC100 - 115V	+ 10%	50/60Hz	
		Single-phase 200V system		Single-phase, AC200 - 230V	+ 10%	50/60Hz	
		3-phase 200V system		3-phase, AC200 - 230V	+ 10%	50/60Hz	
		Permissible frequency variation		Max. ± 5%			
	Control system		IGBT PWM control (sine wave control)				
	Encoder	Rotary encoder		Incremental encoder, 11 wires, 2500 P/r			
	Built-in functions	Regenerative discharge		External regenerative discharge resistor			
		Dynamic brake		Active after Main Power-Off, Servo-Off, protective function and limit switch.			
		Auto gain tuning		Normal and Real time			
		Electronic gear (command pulse ratio)		Calculated as $\frac{1-10000}{1-10000} \times 2^{0-17}$			
		Scale of feedback pulse		11-wire incremental encoder: 1 to 2500 P/r			
	Protective functions	Stores past 14 errors including current one. Alarms marked with *cannot be stored.		Undervoltage, Overvoltage, Overcurrent, Overload, Regenerative discharge, Encoder error, Position error, Over speed, command pulse scaler error, Error counter over flow, EEPROM data error, Alarms (parameter error, check code error) Overtravel inhibit input error, CPU error etc			
	Monitor	Panel indication		Status LED indicator (STATUS), Error LED indicator (ALM CODE)			
		Analogue output (connector pins for monitor) Selects the items to be measured by using a parameter, and measuring range (output impedance of 1kΩ)		Velocity monitor: 6V/3000r/min (rated revolution, default) Torque monitor: 3V/100% (rated torque, default) Position error pulse number			
	Setting	Communication		RS232C			
	Position Control	Max. input pulse frequency		Line driver 500 kpps, Open collector 200 kpps			
		Type		Line driver and open collector			
		Command type		Quadrature pulse command, CW/CCW pulse command and Pulse/direction command			
	Velocity control	Internal velocity command		4 speeds set-up (CW/CCW, Max.1000r/min)			
		Acceleration/deceleration time setting		0 to 10s/1000rpm, individual set-up of acceleration and deceleration, S-shaped acceleration/deceleration			
Rotary encoder	Rotary encoder phase	A/B	Line driver output				
	Feedback signal	Z phase	Output from line driver and open collector				
Input of control signal		See "System Configuration and Wiring".					
Physical structure		Back panel mounting					
Weight		See "Outer Views and Dimensions".					
Working environment		See "Installation".					
Motor	Rated speed		3000r/min				
	Maximum speed		30W-400W:5000r/min.750W:4500r/min				
	Holding brake		DC24V See "Holding brake built in servo motor".				
	Rotary encoder		Incremental encoder, 11 wires, 2500 P/r				
	Structure (Dust proof and drip proof)		IP65 (Except connector, shaft run-through area and reduction gear)				
	Weight		See "Motor outline drawing".				
	Working environment		See "Installation".				
	With reduction gear	Type	GH (High accuracy) type	GS (Standard) type	GL (Popular) type		
		Backlash	2-3' (Initially)		2-3' (Initially)		
		Instantaneous max. input revolution	5000r/min		3600r/min		
Efficiency (Torque rating - Revolution rating at 20°C)		65% min.		75% min.			
Vibration		V-20					
Structure (Combined with motor)		IP44	IP40	IP55			

# After-Sale Service Repair

---

## Repair

Ask the seller where the product was purchased for details of repair work.

When the product is installed in a machine or device, consult first the manufacturer of the machine or device.

## Information

Customer Service

TEL : 072-870-3057-3110

Operating hours : 9:00 to 17:00, Monday to Saturday

(except Sunday, National holiday and the end/beginning of the year)

Memorandum(Fill in the blanks for convenience in case of inquiry or repair)

Date of purchase	Date:	Model No.	MUDS _____ MUMS _____
Place of purchase	Telephone No.(                      )                      —		

**Industrial and Appliance Motor Division, Motor Co., Matsushita Electric Industrial Co.,Ltd.**

1-1, Morofuku 7-chome, Daito, Osaka, Japan 574-0044

TEL:(072)871-1212

IMB36

S0-300-1110