

ACCU ELECTRIC MOTORS INC

USA: (888) 932-9183

CANADA: (905) 829-2505

- ✓ Over 100 years cumulative experience
- ✓ 24 hour rush turnaround / technical support service
- ✓ Established in 1993



The leading independent repairer of servo motors and drives in North America.

Visit us on the web:

www.servo-repair.com

www.servorepair.ca

www.ferrocontrol.com

www.sandvikrepair.com

www.accuelectric.com

Scroll down to view your document!

For 24/7 repair services :

USA: 1 (888) 932 - 9183

Canada: 1 (905) 829 -2505

Emergency After hours: 1 (416) 624 0386

Servicing USA and Canada

■ Contents

Introduction to HVAC	2
Safety regulations	2
Warning against unintended start	2
Installation	4
Mechanical installation	4
IP 00 VLT 6400-6550 380-460 V	6
High voltage warning	7
Earthing	7
Cables	7
Screened/armoured cables	7
Extra protection with regard to indirect contact	7
RFI switch	9
High voltage test	11
Heat emission from VLT 6000 HVAC	11
Ventilation of integrated VLT 6000 HVAC	11
Electrical installation - earthing of control cables	12
Tightening-up torque and screw sizes	13
Mains connection	13
Pre-fuses	13
Motor connection	13
Direction of motor rotation	14
Motor cables	14
Motor thermal protection	15
Earth connection	15
DC bus connection	15
High-voltage relay	15
Control card	15
Connection examples, VLT 6000 HVAC	16
Programming	18
Control unit LCP	18
Control keys for parameter setup	18
Indicator lamps	19
Local control	19
Display mode	19
Navigation between display modes	22
Changing data	23
Manual initialisation	23
Quick Menu	24
All about VLT 6000 HVAC	25
Status messages	25
List of warnings and alarms	27
Index	28



The voltage of the frequency converter is dangerous whenever the equipment is connected to mains. Incorrect installation of the motor or the frequency converter may cause damage to the equipment, serious personal injury or death. Consequently, the instructions in this manual, as well as national and local rules and safety regulations, must be complied with.

■ Safety regulations

1. The frequency converter must be disconnected from mains if repair work is to be carried out. Check that the mains supply has been disconnected and that the necessary time has passed before removing motor and mains plugs.
2. The [OFF/STOP] key on the control panel of the frequency converter does not disconnect the equipment from mains and is thus not to be used as a safety switch.
3. Correct protective earthing of the equipment must be established, the user must be protected against supply voltage, and the motor must be protected against overload in accordance with applicable national and local regulations.
4. The earth leakage currents are higher than 3.5 mA.
5. Protection against motor overload is included in the factory setting. Parameter 117, *Motor thermal protection* default value is ETR trip 1.
Note: The function is initialised at 1.0 x rated motor current and rated motor frequency (see parameter 117, *Motor thermal protection*).

6. Do not remove the plugs for the motor and mains supply while the frequency converter is connected to mains. Check that the mains supply has been disconnected and that the necessary time has passed before removing motor and mains plugs.
7. Reliable galvanic isolation (PELV) is not complied with if the RFI switch is placed in OFF position. This means that all control in - and outputs can only be considered low-voltage terminals with basic galvanic isolation.
8. Please note that the frequency converter has more voltage inputs than L1, L2 and L3, when the DC-bus terminals are used. Check that all voltage inputs have been disconnected and that the necessary time has passed before repair work is commenced.

■ Warning against unintended start

1. The motor can be brought to a stop by means of digital commands, bus commands, references or a local stop, while the frequency converter is connected to mains. If personal safety considerations make it necessary to ensure that no unintended start occurs, these stop functions are not sufficient.
2. While parameters are being changed, the motor may start. Consequently, the stop key [OFF/STOP] must always be activated, following which data can be modified.
3. A motor that has been stopped may start if faults occur in the electronics of the frequency converter, or if a temporary overload or a fault in the supply mains or the motor connection ceases.

■ Use on isolated mains

See section *RFI Switch* regarding use on isolated mains.

It is important to follow the recommendations regarding installation on IT-mains, since sufficient protection of the complete installation must be observed. Not taking care using relevant monitoring devices for IT-mains may result in damage.

**Warning:**

Touching the electrical parts may be fatal - even after the equipment has been disconnected from mains.

- Using VLT 6002 - 6005, 200-240 V: Wait at least 4 minutes
- Using VLT 6006 - 6062, 200-240 V: Wait at least 15 minutes
- Using VLT 6002 - 6005, 380-460 V: Wait at least 4 minutes
- Using VLT 6006 - 6072, 380-460 V: Wait at least 15 minutes
- Using VLT 6102 - 6352, 380-460 V: Wait at least 20 minutes
- Using VLT 6400 - 6550, 380-460 V: Wait at least 15 minutes
- Using VLT 6002 - 6006, 525-600 V: Wait at least 4 minutes
- Using VLT 6008 - 6027, 525-600 V: Wait at least 15 minutes
- Using VLT 6032 - 6072, 525-600 V: Wait at least 30 minutes
- Using VLT 6102 - 6402, 525-600 V: Wait at least 20 minutes

175HA490:13

■ Mechanical installation



Please pay attention to the requirements that apply to integration and field mounting kit, see the below list. The information given in the list must be observed to avoid serious damage or injury, especially when installing large units.

The frequency converter *must* be installed vertically.

The frequency converter is cooled by means of air circulation. For the unit to be able to release its cooling air, the *minimum* distance over and below the unit must be as shown in the illustration below.

To protect the unit from overheating, it must be ensured that the ambient temperature *does not rise above the max. temperature stated for the frequency converter* and that the 24-hour average temperature *is not exceeded*. The max. temperature and 24-hour average can be seen from the *General Technical Data*. If the ambient temperature is in the range of 45°C -55° C, derating of the frequency converter will become relevant, see *Derating for ambient temperature*. The service life of the frequency converter will be reduced if derating for ambient temperature is not taken into account.

■ Installation of VLT 6002-6352

All frequency converters must be installed in a way that ensures proper cooling.

Cooling

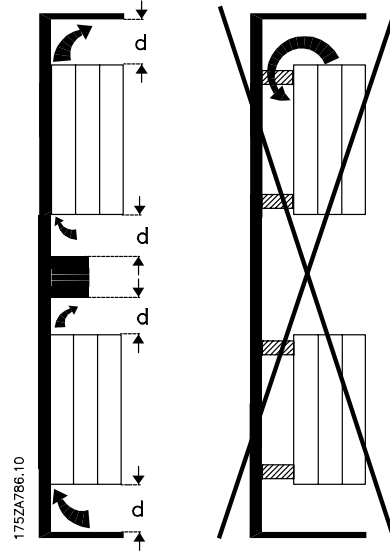

All Bookstyle and Compact units require a minimum space above and below the enclosure.

Side by side/flange by flange

All frequency converters can be mounted side by side/flange by flange.

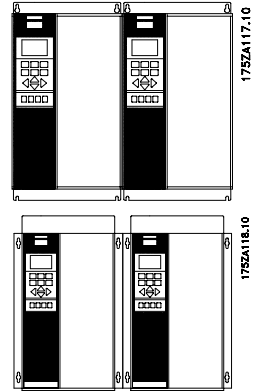
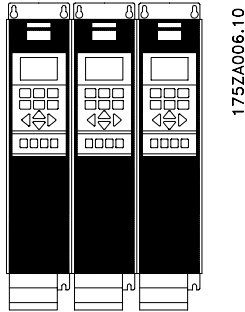

	d [mm]	Comments
Bookstyle		
VLT 6002-6005, 200-240 V	100	Installation on a plane, vertical surface (no spacers)
VLT 6002-6011, 380-460 V	100	
Compact (all enclosure types)		
VLT 6002-6005, 200-240 V	100	Installation on a plane, vertical surface (no spacers)
VLT 6002-6011, 380-460 V	100	
VLT 6002-6011, 525-600 V	100	
VLT 6006-6032, 200-240 V	200	Installation on a plane, vertical surface (no spacers)
VLT 6016-6072, 380-460 V	200	
VLT 6102-6122, 380-460 V	225	
VLT 6016-6072, 525-600 V	200	
VLT 6042-6062, 200-240 V	225	Installation on a plane, vertical surface (no spacers)
VLT 6102-6402, 525-600 V	225	
VLT 6152-6352, 380-460 V	225	IP 54 filter mats must be changed when they are dirty.

■ Installation of VLT 6400-6550 380-460 V Compact
IP 00, IP 20 and IP 54

Cooling

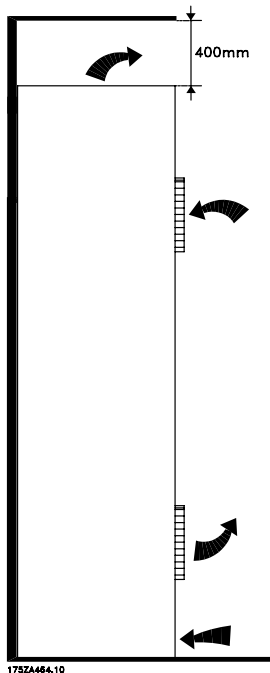

All units in the above-mentioned series require a minimum space of 400 mm above the enclosure and must be installed on a plane floor. This applies to both IP 00, IP 20 and IP 54 units. Gaining access to VLT 6400-6550 requires a minimum space of 605 mm in front of the frequency converter.

Side-by-side

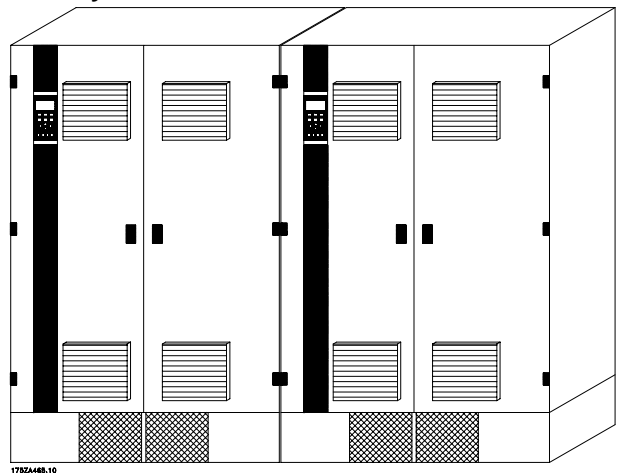

All IP 00, IP 20 and IP 54 units in the above-mentioned series can be installed side by side without any space between them, since these units do not require cooling on the sides.

■ IP 00 VLT 6400-6550 380-460 V

The IP 00 unit is designed for installation in a cabinet when installed according to the instructions in the

VLT 6400-6550 Installation Guide MG.56.AX.YY.

Please note, that the same conditions as for NEMA 1/ IP20 and IP54 must be fulfilled.

■ High voltage warning



The voltage of the frequency converter is dangerous whenever the equipment is connected to mains. Incorrect installation of the motor or the frequency converter may cause damage to the equipment, serious personal injury or death. Consequently, the instructions in this Design Guide, as well as national and local safety regulations, must be complied with. Touching the electrical parts may be fatal - even after disconnection from mains:

Using VLT 6002-6005, 200-240 V wait at least 4 minutes
 Using VLT 6006-6062, 200-240 V wait at least 15 minutes
 Using VLT 6002-6005, 380-460 V wait at least 4 minutes
 Using VLT 6006-6072, 380-460 V wait at least 15 minutes
 Using VLT 6102-6352, 380-460 V wait at least 20 minutes
 Using VLT 6400-6550, 380-460 V wait at least 15 minutes
 Using VLT 6002-6006, 525-600 V wait at least 4 minutes
 Using VLT 6008-6027, 525-600 V wait at least 15 minutes
 Using VLT 6032-6072, 525-600 V wait at least 30 minutes
 Using VLT 6102-6402, 525-600 V wait at least 20 minutes



NB!:

It is the user's or certified electrician's responsibility to ensure correct earthing and protection in accordance with applicable national and local norms and standards.

■ Earthing

The following basic issues need to be considered when installing a frequency converter, so as to obtain electromagnetic compatibility (EMC).

- Safety earthing: Please note that the frequency converter has a high leakage current and must be earthed appropriately for safety reasons. Apply local safety regulations.
- High-frequency earthing: Keep the earth wire connections as short as possible.

Connect the different earth systems at the lowest possible conductor impedance. The lowest possible conductor impedance is obtained by keeping the conductor as short as possible and by using the greatest possible surface area. A flat conductor, for

example, has a lower HF impedance than a round conductor for the same conductor cross-section C_{VESS} . If more than one device is installed in cabinets, the cabinet rear plate, which must be made of metal, should be used as a common earth reference plate. The metal cabinets of the different devices are mounted on the cabinet rear plate using the lowest possible HF impedance. This avoids having different HF voltages for the individual devices and avoids the risk of radio interference currents running in connection cables that may be used between the devices. The radio interference will have been reduced. In order to obtain a low HF impedance, use the fastening bolts of the devices as HF connection to the rear plate. It is necessary to remove insulating paint or similar from the fastening points.

■ Cables

Control cables and the filtered mains cable should be installed separate from the motor cables so as to avoid interference overcoupling. Normally, a distance of 20 cm will be sufficient, but it is recommended to keep the greatest possible distance wherever possible, especially where cables are installed in parallel over a substantial distance. With respect to sensitive signal cables, such as telephone cables and data cables, the greatest possible distance is recommended with a minimum of 1 m per 5 m of power cable (mains and motor cable). It must be pointed out that the necessary distance depends on the sensitivity of the installation and the signal cables, and that therefore no precise values can be stated. If cable jaws are used, sensitive signal cables are not to be placed in the same cable jaws as the motor cable or brake cable. If signal cables are to cross power cables, this should be done at an angle of 90 degrees. Remember that all interference-filled in- or outgoing cables to/from a cabinet should be screened/armoured or filtered. See also *EMC-correct electrical installation*.

■ Screened/armoured cables

The screen must be a low HF-impedance screen. This is ensured by using a braided screen of copper, aluminium or iron. Screen armour intended for mechanical protection, for example, is not suitable for an EMC-correct installation. See also *Use of EMC-correct cables*.

■ Extra protection with regard to indirect contact

ELCB relays, multiple protective earthing or earthing can be used as extra protection, provided that local safety regulations are complied with. In the case of an earth fault, a DC content may develop in the faulty current.

Never use ELCB relays, type A, since such relays are not suitable for DC fault currents.

If ELCB relays are used, this must be:

- Suitable for protecting equipment with a direct current content (DC) in the faulty current (3-phase bridge rectifier)
- Suitable for power-up with short charging current to earth
- Suitable for a high leakage current

■ RFI switch

Mains supply isolated from earth:

If the frequency converter is supplied from an isolated mains source (IT mains) or TT/TN-S mains with grounded leg, the RFI switch is recommended to be turned off (OFF)¹⁾. For further reference, see IEC 364-3. In case optimum EMC performance is needed, parallel motors are connected or the motor cable length is above 25 m, it is recommended to set the switch in ON position.

In OFF position, the internal RFI capacities (filter capacitors) between the chassis and the intermediate circuit are cut off to avoid damage to the intermediate circuit and to reduce the earth capacity currents (according to IEC 61800-3).

Please also refer to the application note *VLT on IT mains*, MN.90.CX.02. It is important to use isolation monitors that are capable for use together with power electronics (IEC 61557-8).



NB!:

The RFI switch is not to be operated with mains connected to the unit. Check that the mains supply has been disconnected before operating the RFI switch.



NB!:

Open RFI switch is only allowed at factory set switching frequencies.



NB!:

The RFI switch connects the capacitors galvanically to earth.

The red switches are operated by means of e.g. a screwdriver. They are set in the OFF position when they are pulled out and in ON position when they are pushed in. Factory setting is ON.

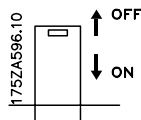

Mains supply connected to earth:

The RFI switch must be in ON position in order for the frequency converter to comply with the EMC standard.

1) Not possible with 6102-6402, 525-600 V units.

Position of RFI switches



Bookstyle IP 20

VLT 6002 - 6011 380 - 460 V

VLT 6002 - 6005 200 - 240 V

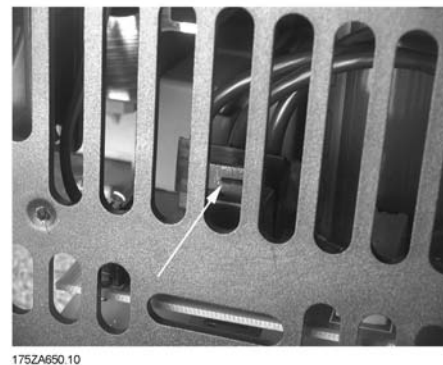

Compact IP 20 and NEMA 1

VLT 6002 - 6011 380 - 460 V

VLT 6002 - 6005 200 - 240 V

VLT 6002 - 6011 525 - 600 V



Compact IP 20 and NEMA 1

VLT 6016 - 6027 380 - 460 V

VLT 6006 - 6011 200 - 240 V

VLT 6016 - 6027 525 - 600 V



Compact IP 20 and NEMA 1
VLT 6032 - 6042 380 - 460 V
VLT 6016 - 6022 200 - 240 V
VLT 6032 - 6042 525 - 600 V

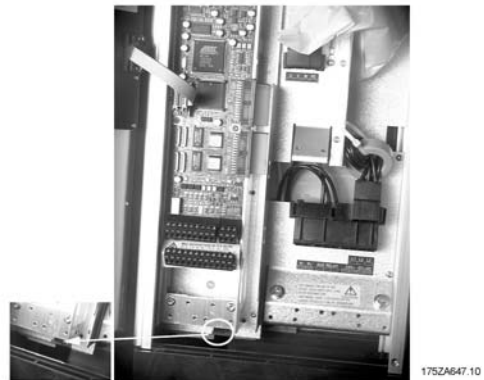

Compact IP 54
VLT 6002 - 6011 380 - 460 V
VLT 6002 - 6005 200 - 240 V

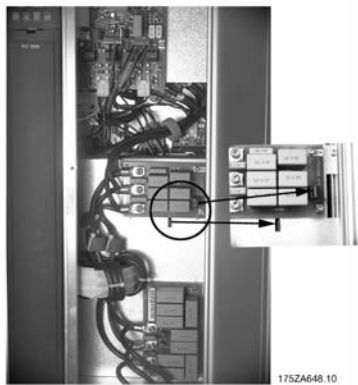

Compact IP 20 and NEMA 1
VLT 6052 - 6122 380 - 460 V
VLT 6027 - 6032 200 - 240 V
VLT 6052 - 6072 525 - 600 V



Compact IP 54
VLT 6016 - 6032 380 - 460 V
VLT 6006 - 6011 200 - 240 V

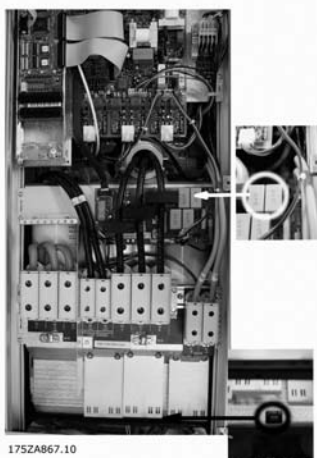

Compact IP 54
VLT 6102 - 6122 380 - 460 V



Compact IP 54
VLT 6042 - 6072 380 - 460 V
VLT 6016 - 6032 200 - 240 V

■ High voltage test

A high voltage test can be carried out by short-circuiting terminals U, V, W, L1, L2 and L3 and energizing by max. 2.5 kV DC for one second between this short-circuit and the chassis.

NB!:

The RFI switch must be closed (position ON) when high voltage tests are carried out.

The mains and motor connection must be interrupted in the case of high voltage tests of the total installation if the leakage currents are too high.

■ Heat emission from VLT 6000 HVAC

The tables in *General technical data* show the power loss P_{Φ} (W) from VLT 6000 HVAC. The maximum cooling air temperature $t_{IN, MAX}$, is 40° at 100% load (of rated value).

■ Ventilation of integrated VLT 6000 HVAC

The quantity of air required for cooling frequency converters can be calculated as follows:

1. Add up the values of P_{Φ} for all the frequency converters to be integrated in the same panel. The highest cooling air temperature (t_{IN}) present must be lower than $t_{IN, MAX}$ (40°C). The day/night average must be 5°C lower (VDE 160). The outlet temperature of the cooling air must not exceed: $t_{OUT, MAX}$ (45° C).
2. Calculate the permissible difference between the temperature of the cooling air (t_{IN}) and its outlet temperature (t_{OUT}):
 $\Delta t = 45^{\circ} C - t_{IN}$.
3. Calculate the required quantity of air = $\frac{\sum P_{\Phi} \times 3.1}{\Delta t}$ m³/h
 insert Δt in Kelvin

The outlet from the ventilation must be placed above the highest-mounted frequency converter. Allowance must be made for the pressure loss across the filters and for the fact that the pressure is going to drop as the filters are choked.

■ **Electrical installation - earthing of control cables**

Generally speaking, control cables must be braided screened/armoured and the screen must be connected by means of a cable clamp at both ends to the metal cabinet of the unit.

The drawing below indicates how correct earthing is carried out and what to be done if in doubt.

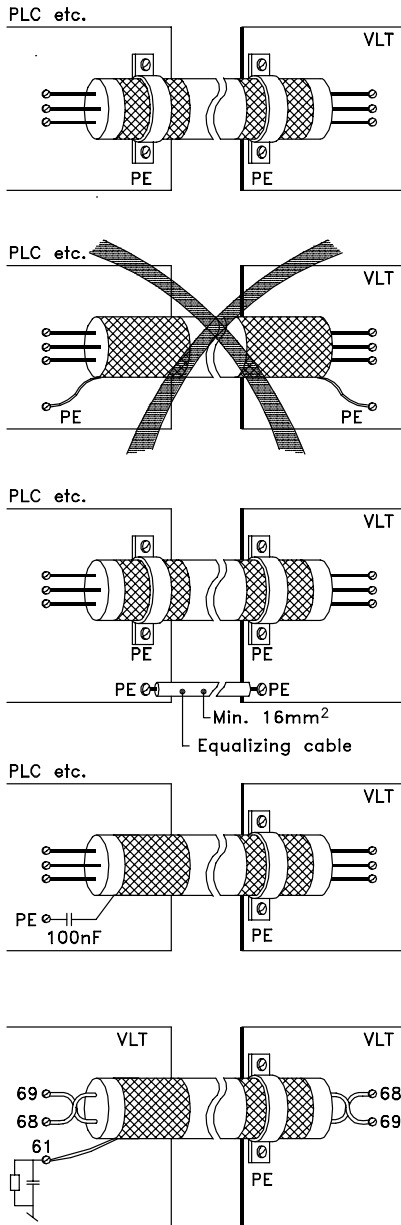

175ZA165.11

Correct earthing

Control cables and cables for serial communication must be fitted with cable clamps at both ends to ensure the best possible electrical contact

Wrong earthing

Do not use twisted cable ends (pigtails), since these increase the screen impedance at high frequencies.

Protection with respect to earth potential between PLC and VLT

If the earth potential between the frequency converter and the PLC (etc.) is different, electric noise may occur that will disturb the whole system. This problem can be solved by fitting an equalising cable, to be placed next to the control cable. Minimum cable cross-section: 16 mm².

For 50/60 Hz earth loops

If very long control cables are used, 50/60 Hz earth loops may occur. This problem can be solved by connecting one end of the screen to earth via a 100nF capacitor (keeping leads short).

Cables for serial communication

Low-frequency noise currents between two frequency converters can be eliminated by connecting one end of the screen to terminal 61. This terminal is connected to earth via an internal RC link. It is recommended to use twisted-pair cables to reduce the differential mode interference between the conductors.

■ Tightening-up torque and screw sizes

The table shows the torque required when fitting terminals to the frequency converter. For VLT 6002-6032, 200-240 V, VLT 6002-6122, 380-460 and 525-600 V the cables must be fastened with screws. For VLT 6042-6062, 200-240 V and for VLT 6152-6550, 380-460 V, the cables must be fastened with bolts.

These figures apply to the following terminals:

Mains terminals (Nos.)	91, 92, 93 L1, L2, L3
Motor terminals (Nos.)	96, 97, 98 U, V, W
Earth terminal (Nos.)	94, 95, 99

VLT type	Tightening-up torque	Screw/bolt size	Allen key size
3 x 200 - 240 V			
VLT 6002-6005	0.5-0.6 Nm	M3	
VLT 6006-6011	1.8 Nm (IP 20)	M4	
VLT 6006-6016	1.8 Nm (IP 54)	M4	
VLT 6016-6027	3.0 Nm (IP 20)	M5 ³⁾	4 mm
VLT 6022-6027	3.0 Nm (IP 54) ²⁾	M5 ³⁾	4 mm
VLT 6032	6.0 Nm	M6 ³⁾	5 mm
VLT 6042-6062	11.3 Nm	M8 (bolt)	
3 x 380-460 V			
VLT type	Tightening-up torque	Screw/bolt size	Allen key size
VLT 6002-6011	0.5-0.6 Nm	M3	
VLT 6016-6027	1.8 Nm (IP 20)	M4	
VLT 6016-6032	1.8 Nm (IP 54)	M4	
VLT 6032-6052	3.0 Nm (IP 20)	M5 ³⁾	4 mm
VLT 6042-6052	3.0 Nm (IP 54) ²⁾	M5 ³⁾	4 mm
VLT 6062-6072	6.0 Nm	M6 ³⁾	5 mm
VLT 6102-6122	15 Nm (IP 20)	M8 ³⁾	6 mm
	24 Nm (IP 54) ¹⁾	3)	8 mm
VLT 6152-6352	19 Nm ⁴⁾	M10 (bolt)	
VLT 6400-6550	42 Nm	M12 (bolt)	
3 x 525-600 V			
VLT type	Tightening-up torque	Screw/bolt size	Allen key size
VLT 6002-6011	0.5-0.6 Nm	M3	
VLT 6016-6027	1.8 Nm	M4	
VLT 6032-6042	3.0 Nm ²⁾	M5 ³⁾	4 mm
VLT 6052-6072	6.0 Nm	M6 ³⁾	5 mm
VLT 6102-6402	19 Nm ⁴⁾	M10 (bolt)	

1. Loadsharing terminals 14 Nm/M6, 5 mm Allen key
2. IP 54 units with RFI filter line terminals 6 Nm
3. Allen screws (hexagon)
4. Loadsharing terminals 9.5 Nm/M8 (bolt)

■ Mains connection

Mains must be connected to terminals 91, 92, 93.
 Mains voltage 3 x 200-240 V
 91, 92, 93 Mains voltage 3 x 380-460 V
 L1, L2, L3 Mains voltage 3 x 525-600 V



NB!:

Check that the mains voltage fits the mains voltage of the frequency converter, which can be seen from the nameplate.

See *Technical data* for correct sizing of cable cross-sections.

■ Pre-fuses

See *Technical data* for correct sizing of pre-fuses.

■ Motor connection

The motor must be connected to terminals 96, 97, 98. Earth to terminal 94/95/99.

Nos.	
96. 97. 98	Motor voltage 0-100 % of mains voltage
U, V, W	
No. 94/95/99	Earth connection

See *Technical data* for correct sizing of cable cross-sections.

All types of three-phase asynchronous standard motors can be used with a VLT 6000 HVAC unit.

Small-size motors are normally star-connected. (220/380 V, Δ/Y). Large-size motors are delta-connected (380/660 V, Δ/Y). The correct connection and voltage can be read from the motor nameplate.



NB!:

In older motors without phase coil insulation, a LC filter should be fitted to the frequency converter output. See the Design Guide or contact Danfoss.

See *Technical data* for correct sizing of cable cross-sections.

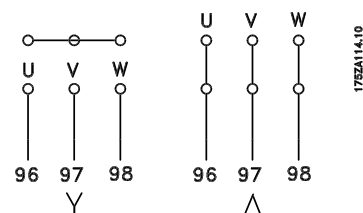

■ Direction of motor rotation

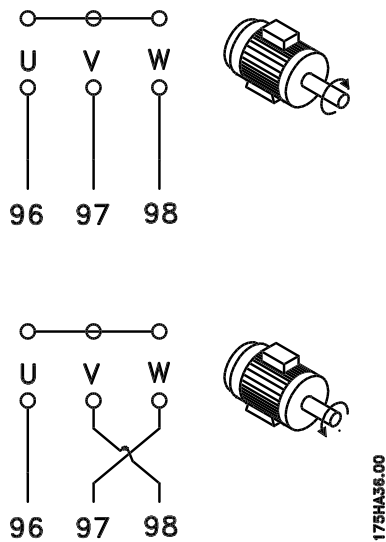

The factory setting is for clockwise rotation with the frequency transformer output connected as follows.

- Terminal 96 connected to U-phase
- Terminal 97 connected to V-phase
- Terminal 98 connected to W-phase

The direction of motor rotation can be changed by switching two phases in the motor cable.

Problems may arise at the start and at low rpm values if the motor sizes are widely different. This is because the relatively high ohmic resistance in small motors calls for a higher voltage at the start and at low rpm values. In systems with motors connected in parallel, the electronic thermal relay (ETR) of the frequency converter cannot be used as motor protection for the individual motor. Consequently, additional motor protection is required, such as thermistors in each motor (or individual thermal relays).

NB!
 Parameter 107 *Automatic Motor Adaptation*, AMA and *Automatic Energy Optimization*, AEO in parameter 101 *Torque characteristics* cannot be used if motors are connected in parallel.

■ Motor cables

See *Technical data* for correct sizing of motor cable cross-section and length. Always comply with national and local regulations on cable cross-sections.

NB!
 If an unscreened cable is used, some EMC requirements are not complied with, see *EMC test results*.

■ Parallel coupling of motors

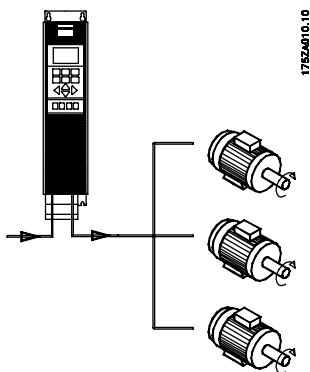

VLT 6000 HVAC is able to control several motors connected in parallel. If the motors are to have different rpm values, the motors must have different rated rpm values. Motor rpm is changed simultaneously, which means that the ratio between the rated rpm values is maintained across the range. The total current consumption of the motors is not to exceed the maximum rated output current $I_{VLT,N}$ for the frequency converter.

If the EMC specifications regarding emission are to be complied with, the motor cable must be screened, unless otherwise stated for the RFI filter in question. It is important to keep the motor cable as short as possible so as to reduce the noise level and leakage currents to a minimum. The motor cable screen must be connected to the metal cabinet of the frequency converter and to the metal cabinet of the motor. The screen connections are to be made with the biggest possible surface (cable clamp). This is enabled by different installation devices in the different frequency converters. Mounting with twisted screen ends (pigtailed) is to be avoided, since these spoil the screening effect at higher frequencies. If it is necessary to break the screen to install a motor isolator or motor contactor, the screen must be continued at the lowest possible HF impedance.

■ Motor thermal protection

The electronic thermal relay in UL-approved frequency converters has received UL-approval for single motor protection, as long as parameter 117 *Motor thermal protection* has been set to ETR Trip and parameter 105 *Motor current $I_{VLT,N}$* , has been programmed for the rated motor current (can be read from the motor nameplate).

protective cover (see drawing below) can be removed by means of a pointed object - a screwdriver or similar.

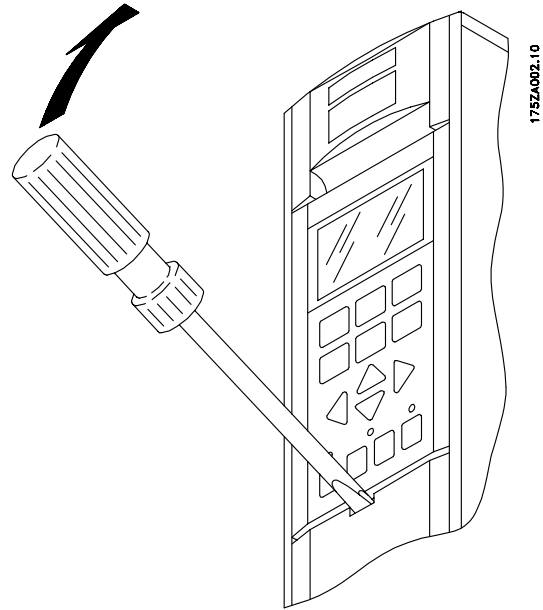

■ Earth connection

Since the leakage currents to earth may be higher than 3.5 mA, the frequency converter must always be earthed in accordance with applicable national and local regulations. In order to ensure good mechanical connection of the earth cable, its cable cross-section must be at least 10 mm². For added security, an RCD (Residual Current Device) may be installed. This ensures that the frequency converter will cut out if the leakage currents get too high. See RCD instructions MI.66.AX.02.

■ DC bus connection

The DC bus terminal is used for DC back-up, with the intermediate circuit being supplied from an external DC source.

Terminal nos. 88, 89

Contact Danfoss if you require further information.

■ High-voltage relay

The cable for the high-voltage relay must be connected to terminals 01, 02, 03. The high-voltage relay is programmed in parameter 323, *Relay 1, out-put*.

No. 1	Relay output 1 1+3 break, 1+2 make Max 240 V AC, 2 Amp Min. 24 V DC 10 mA or 24 V AC, 100 mA
Max Cross-section:	4 mm ² /10 AWG
Torque:	0.5-0.6 Nm
Screw size:	M3

■ Control card

All terminals for the control cables are located under the protective cover of the frequency converter. The

■ Connection examples, VLT 6000 HVAC

The diagram below gives an example of a typical VLT 6000 HVAC installation.

The mains supply is connected to terminals 91 (L1), 92 (L2) and 93 (L3), while the motor is connected to 96 (U), 97 (V) and 98 (W). These numbers can also be seen from the terminals of the frequency converter.

An external DC supply or a 12-pulse option can be connected to terminals 88 and 89. Please ask Danfoss for a Design Guide to learn more.

Analogue inputs can be connected to terminals 53 [V], 54 [V] and 60 [mA]. These inputs can be programmed for either reference, feedback or thermistor. See *Analogue inputs* in parameter group 300.

There are 8 digital inputs, which can be connected to terminals 16-19, 27, 29, 32, 33. These inputs can be programmed in accordance with the table in *Inputs and outputs 300-328*.

There are two analogue/digital outputs (terminals 42 and 45), which can be programmed to show the present status or a process value, such as $0-f_{MAX}$. Relay outputs 1 and 2 can be used for giving the present status or a warning.

On terminals 68 (P+) and 69 (N-) RS 485 interface, the frequency converter can be controlled and monitored via serial communication.

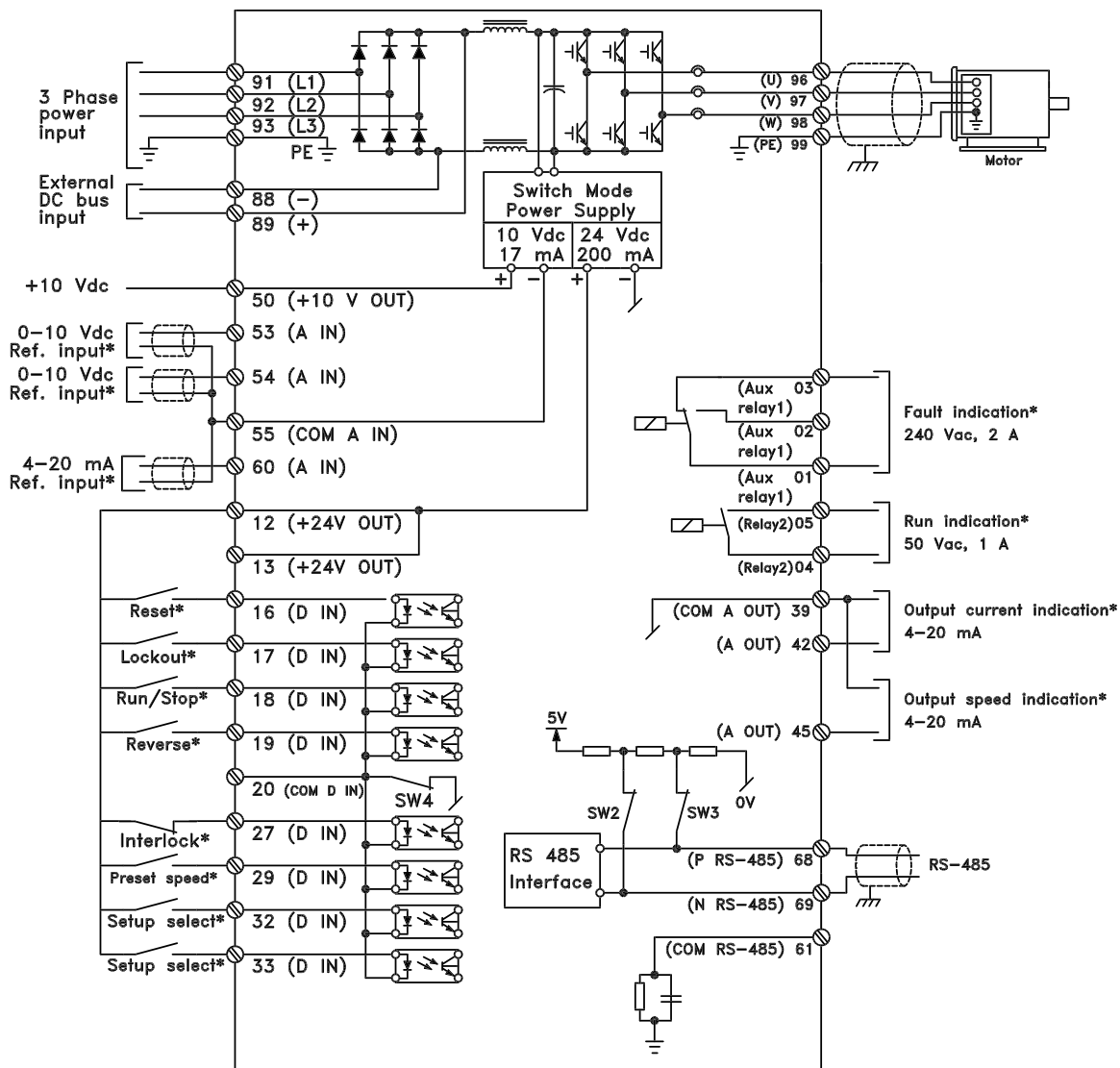

175HA390.12

■ Electrical installation, control cables

Max. control cable cross section: 1.5 mm² /16 AWG

Torque: 0.5-0.6 Nm

Screw size: M3

See *Earthing of screened/armoured control cables* for correct termination of control cables.

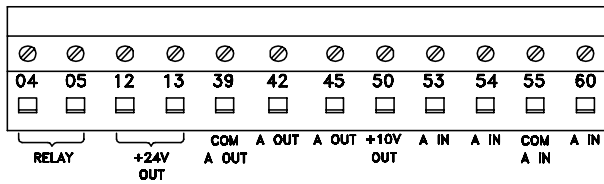
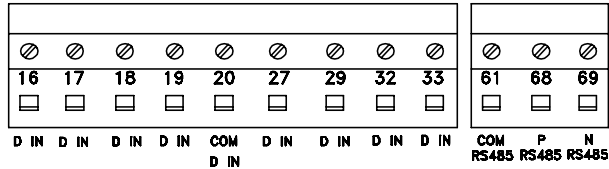

175HA379.10

No.	Function
04, 05	Relay output 2 can be used for indicating status and warnings.
12, 13	Voltage supply to digital inputs. For the 24 V DC to be used for digital inputs, switch 4 on the control card must be closed, position "on".
16-33	Digital inputs. See parameters 300-307 <i>Digital inputs</i> .
20	Ground for digital inputs.
39	Ground for analogue/digital outputs. Must be connected to terminal 55 by means of a three-wire transmitter. See <i>Examples of connection</i> .
42, 45	Analogue/digital outputs for indicating frequency, reference, current and torque. See parameters 319-322 <i>Analogue/digital outputs</i> .
50	Supply voltage to potentiometer and thermistor 10 V DC.
53, 54	Analogue voltage input, 0 - 10 V DC.
55	Ground for analogue voltage inputs.
60	Analogue current input 0/4-20 mA. See parameters 314-316 <i>Terminal 60</i> .
61	Termination of serial communication. See <i>Earthing of screened/armoured control cables</i> . This terminal is not normally to be used.
68, 69	RS 485 interface, serial communication. Where the frequency converter is connected to a bus, switches 2 and 3 (switches 1- 4 - see next page) must be closed on the first and the last frequency converter. On the remaining frequency converters, switches 2 and 3 must be open. The factory setting is closed (position on).

■ Control unit LCP

The front of the frequency converter features a control panel - LCP(Local Control Panel). This is a complete interface for operation and programming of the frequency converter.

The control panel is detachable and can - as an alternative - be installed up to 3 metres away from the frequency converter, e.g. on the front panel, by means of a mounting kit option.

The functions of the control panel can be divided into five groups:

1. Display
2. Keys for changing display mode
3. Keys for changing program parameters
4. Indicator lamps
5. Keys for local operation

All data are indicated by means of a 4-line alphanumeric display, which, in normal operation, is able to show 4 operating data values and 3 operating condition values continuously. During programming, all the information required for quick, effective parameter Setup of the frequency converter will be displayed. As a supplement to the display, there are three indicator lamps for voltage (ON), warning (WARNING) and alarm (ALARM), respectively. All frequency converter parameter Setups can be changed immediately via the control panel, unless this function has been programmed to be *Locked* [1] via parameter 016 *Lock for data change* or via a digital input, parameters 300-307 *Data change lock*.

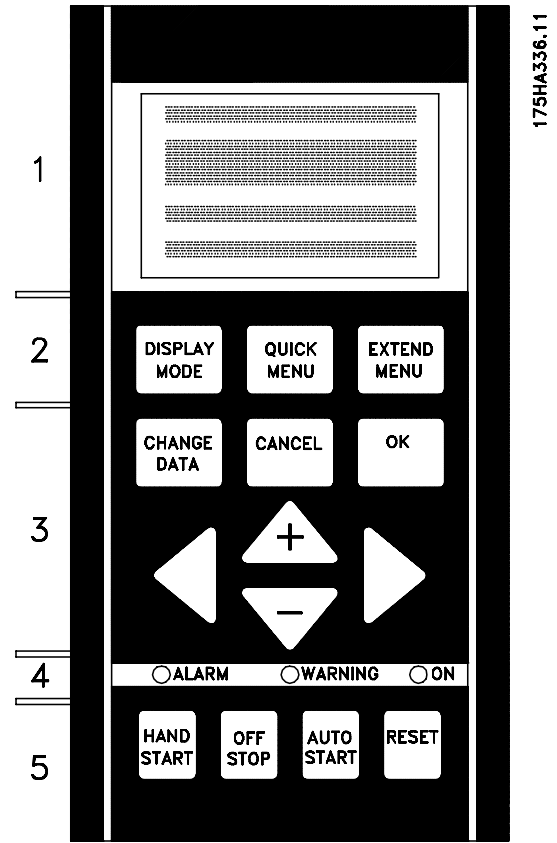

■ Control keys for parameter setup

The control keys are divided into functions. This means that the keys between display and indicator lamps are used for parameter Setup, including selecting the display indication during normal operation.

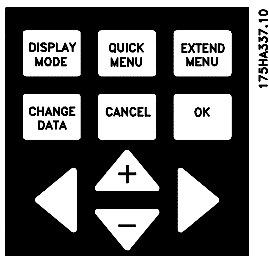

DISPLAY MODE

[DISPLAY MODE] is used for selecting the indication mode of the display or when returning to the Display mode from either the Quick menu or the Extend menu mode.

QUICK MENU

[QUICK MENU] gives access to the parameters used for the Quick menu. It is possible to switch between the Quick menu and the Extend menu modes.

EXTEND MENU

[EXTEND MENU] gives access to all parameters. It is possible to switch between the Extend menu and the Quick menu modes.

CHANGE DATA

[CHANGE DATA] is used for changing a setting selected either in the Extend menu or the Quick menu mode.

CANCEL

[CANCEL] is used if a change of the selected parameter is not to be carried out.

OK

[OK] is used for confirming a change of the parameter selected.

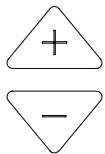

[+/-] is used for selecting parameters and for changing a chosen parameter. These keys are also used to change the local reference. In addition, the keys are used in Display mode to switch between operation variable readouts.

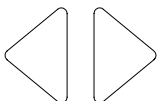

[<>] is used when selecting a parameter group and for moving the cursor when changing numerical values.

Indicator lamps

At the bottom of the control panel is a red alarm lamp and a yellow warning lamp, as well as a green voltage LED.

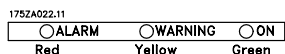

If certain threshold values are exceeded, the alarm and/ or warning lamp is activated, and a status or alarm text is displayed.



NB!

The voltage indicator lamp is activated when the frequency converter receives voltage.

Local control

Underneath the indicator lamps are keys for local control.

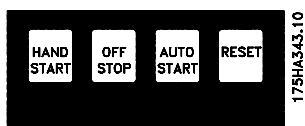

[HAND START] is used if the frequency converter is to be controlled via the control unit. The frequency converter will start the motor, since a start command is given by means of [HAND START].

On the control terminals, the following control signals will still be active when [HAND START] is activated:

- Hand start - Off stop - Auto start
- Safety Interlock
- Reset
- Coasting stop inverse
- Reversing
- Setup select lsb - Setup select msb
- Jog
- Run permissive
- Lock for data change
- Stop command from serial communication



NB!

If parameter 201 *Output frequency low limit* f_{MIN} is set to an output frequency greater than 0 Hz, the motor will start and ramp up to this frequency when [HAND START] is activated.



[OFF/STOP] is used for stopping the connected motor. Can be selected as Enable [1] or Disable [0] via parameter 013. If the stop function is activated, line 2 will flash.



[AUTO START] is used if the frequency converter is to be controlled via the control terminals and/or serial communication. When a start signal is active on the control terminals and/or the bus, the frequency converter will start.



NB!

An active HAND-OFF-AUTO signal via the digital inputs will have higher priority than the control keys [HAND START]-[AUTO START].



[RESET] is used for resetting the frequency converter after an alarm (trip). Can be selected as *Enable* [1] or *Disable* [0] via parameter 015 *Reset on LCP*. See also *List of warnings and alarms*.

■ Display mode

In normal operation, any 4 different operating variables can be indicated continuously: 1.1 and 1.2 and 1.3 and 2. The present operating status or alarms and warnings that have arisen are shown in line 2 in the form of a number. In the case of alarms, the alarm in question will be shown in lines 3 and 4, accompanied by an explanatory note. Warnings will flash in line 2, with an explanatory note in line 1. In addition, the display shows the active Setup. The arrow indicates the direction of rotation; here the frequency converter has an active reversing signal. The arrow body disappears if a stop command is given or if the output frequency falls below 0.01 Hz. The bottom line gives the status of the frequency converter. The scroll list on the next page gives the operating data that can be shown for variable 2 in display mode. Changes are made via the [+/-] keys.



■ Display mode, cont.

Three operating data values can be shown in the first display line, while one operating variable can be shown in the second display line. To be programmed via parameters 007, 008, 009 and 010 *Display read-out*.

- Status line (4th line):

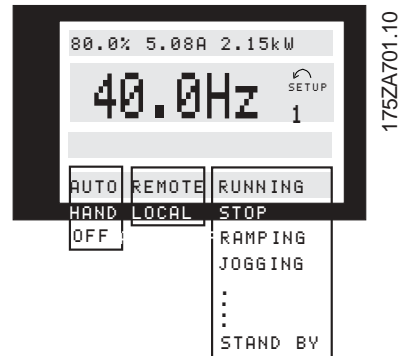

The left part of the status line indicates the control element of the frequency converter that is active. AUTO means that control is via the control terminals, while HAND indicates that control is via the local keys on the control unit. OFF means that the frequency converter ignores all control commands and stops the motor. The centre part of the status line indicates the reference element that is active. REMOTE means that the reference from the control terminals is active, while LOCAL indicates that the reference is determined via the [+/-] keys on the control panel.

The last part of the status line indicates the current status, for example "Running", "Stop" or "Alarm".

■ Display mode I:

VLT 6000 HVAC offers different display modes depending on the mode selected for the frequency converter. The figure on the next page shows the way to navigate between different display modes. Below is a display mode, in which the frequency converter is in Auto mode with remote reference at an output frequency of 40 Hz. In this display mode, reference and control are determined via the control terminals. The text in line 1 gives the operating variable shown in line 2.

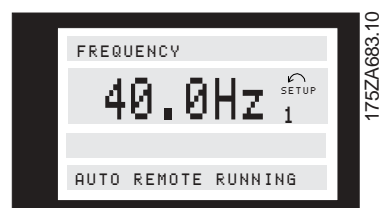

Line 2 gives the current output frequency and the active Setup.

Line 4 says that the frequency converter is in Auto mode with remote reference, and that the motor is running.

■ Display mode II:

This display mode makes it possible to have three operating data values displayed at the same time in line 1. The operating data values are determined in parameters 007-010 *Display readout*.

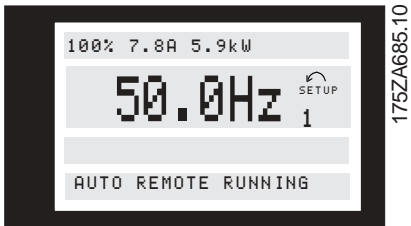

■ Display mode III:

This display mode is active as long as the [DISPLAY MODE] key is kept depressed. In the first line, operating data names and units of operating data are displayed. In the second line, operating data 2 remains unchanged. When the key is released, the different operating data values are shown.

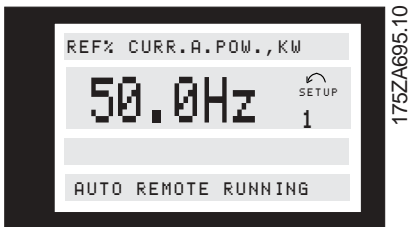

■ Display mode IV:

This display mode is only active in connection with local reference, see also *Reference handling*. In this display mode, the reference is determined via the [+/-] keys and control is carried out by means of the keys underneath the indicator lamps. The first line indicates the required reference. The third line gives the relative value of the present output frequency at any given time in relation to the maximum frequency. The display is in the form of a bar graph.

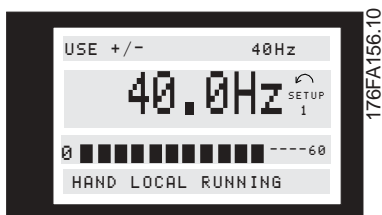

■ Navigation between display modes

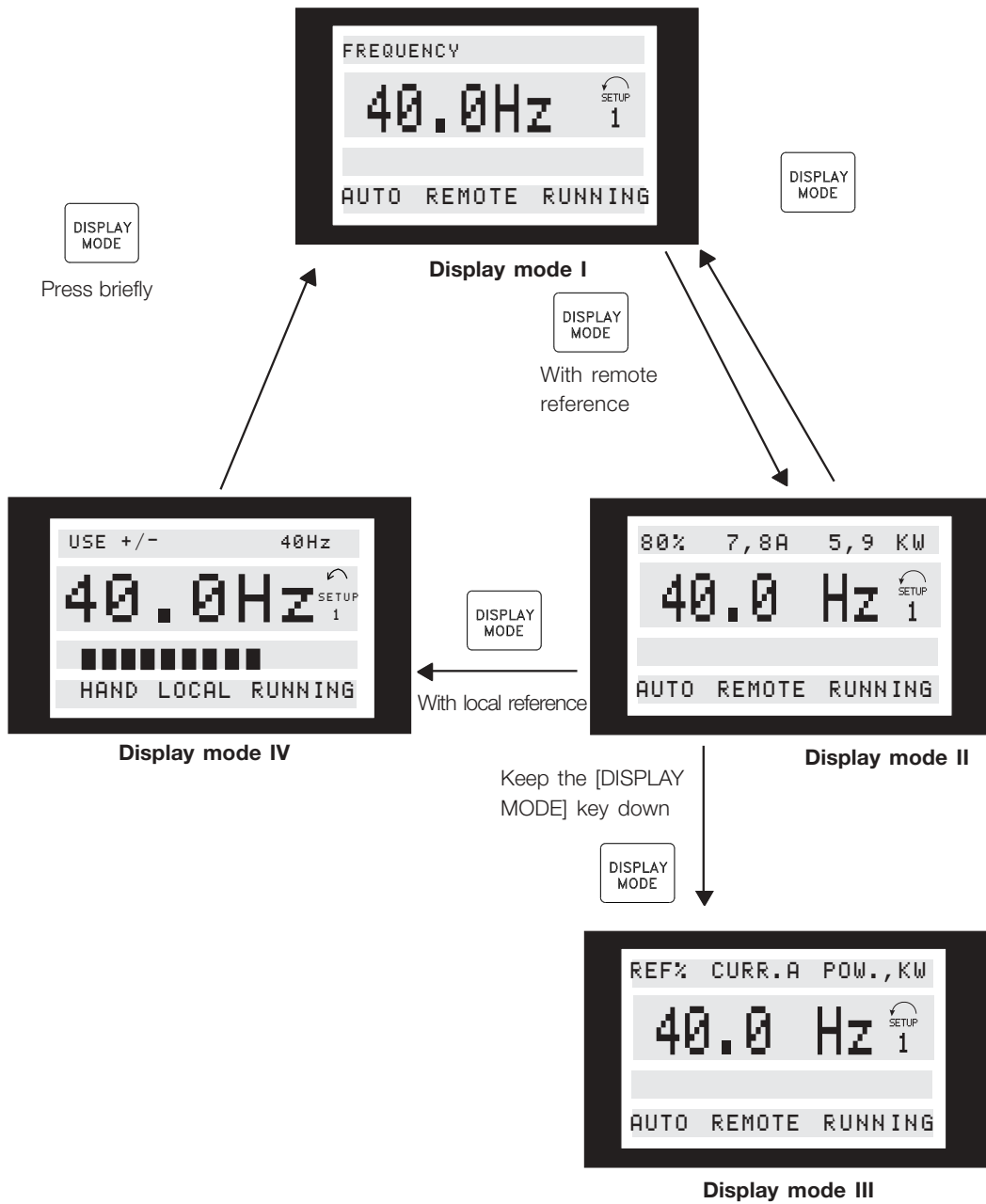

175ZA697.10

■ Changing data

Regardless of whether a parameter has been selected under the Quick menu or the Extended menu, the procedure for changing data is the same. Pressing the [CHANGE DATA] key allows change of the selected parameter, and the underlining in line 4 will flash on the display.

The procedure for changing data depends on whether the selected parameter represents a numerical data value or a functional value.

If the chosen parameter represents a numeric data value, the first digit can be changed by means of the [+/-] keys. If the second digit is to be changed, first move the cursor by using the [<>] keys, then change the data value using the [+/-] keys.

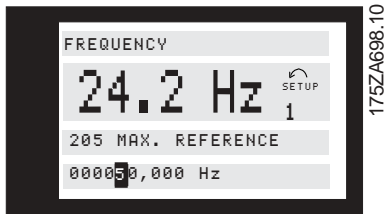

The selected digit is indicated by a flashing cursor. The bottom display line gives the data value that will be entered (saved) when signing off by pressing the [OK] button. Use [CANCEL] to cancel the change.

If the selected parameter is a functional value, the selected text value can be changed by means of the [+/-] keys.

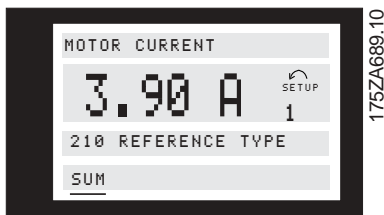

The functional value flashes until signing off by pressing the [OK] button. The functional value has now been selected. Use [CANCEL] to cancel the change.

■ Infinitely variable change of numeric data value

If the chosen parameter represents a numeric data value, a digit is first selected by means of the [<>] keys.

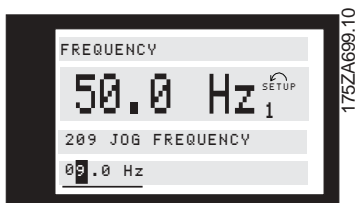

Then the chosen digit is changed infinitely by means of the [+/-] keys:

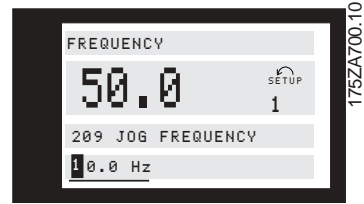

The chosen digit flashes. The bottom display line shows the data value that will be entered (saved) when signing off with [OK].

■ Changing of data value, step-by-step

Certain parameters can be changed both step by step and infinitely variably. This applies to *Motor power* (parameter 102), *Motor voltage* (parameter 103) and *Motor frequency* (parameter 104).

This means that the parameters are changed both as a group of numeric data values and as numeric data values infinitely variably.

■ Manual initialisation

Disconnect from mains and hold the [DISPLAY MODE] + [CHANGE DATA] + [OK] keys down while at the same time reconnecting the mains supply. Release the keys; the frequency converter has now been programmed for the factory setting.

The following parameters are not zeroed by means of manual initialisation:

Parameter	Description
500	Protocol
600	Operating hours
601	hours run
602	kWh counter
603	Number of power-ups
604	Number of overtemperatures
605	Number of overvoltages

It is also possible to carry out initialisation via parameter 620 *Operating mode*.

■ Quick Menu

The QUICK MENU key gives access to 12 of the most important setup parameters of the drive. After programming, the drive will, in many cases, be ready for operation. The 12 Quick Menu parameters are

shown in the table below. A complete description of the function is given in the parameter sections of this manual.

Quick Menu Item Number	Parameter Name	Description
1	001 Language	Selects language used for all displays.
2	102 Motor Power	Sets output characteristics of drive based on kW size of motor.
3	103 Motor Voltage	Sets output characteristics of drive based on voltage of motor.
4	104 Motor Frequency	Sets output characteristics of drive based on nominal frequency of motor. This is typically equal to line frequency.
5	105 Motor Current	Sets output characteristics of drive based on nominal current in amps of motor.
6	106 Motor Nominal Speed	Sets output characteristics of drive based on nominal full load speed of motor.
7	201 Minimum Frequency	Sets minimum controlled frequency at which motor will run.
8	202 Maximum Frequency	Sets maximum controlled frequency at which motor will run.
9	206 Ramp Up Time	Sets time to accelerate motor from 0 Hz to nominal motor frequency set in Quick Menu Item 4.
10	207 Ramp Down Time	Sets time to decelerate motor from nominal motor frequency set in Quick Menu Item 4 to 0 Hz.
11	323 Relay1 Function	Sets function of high voltage Form C relay.
12	326 Relay 2 Function	Sets function of low voltage Form A relay.

■ Status messages

Status messages appear in the 4th line of the display - see example below.

The left part of the status line indicates the active type of control of the frequency converter.

The centre part of the status line indicates the active reference.

The last part of the status line gives the present status, e.g. "Running", "Stop" or "Stand by".

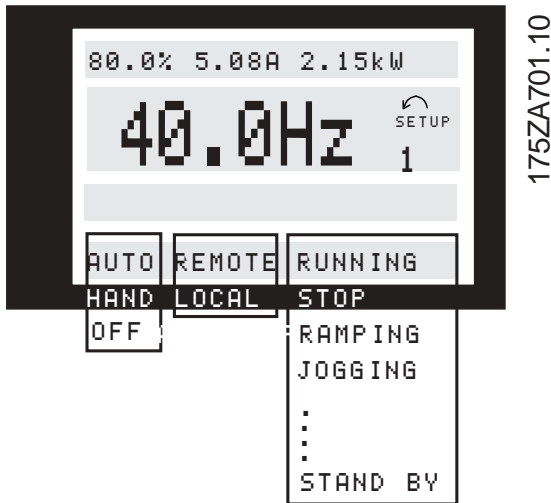

Auto mode (AUTO)

The frequency converter is in Auto mode, i.e. control is carried out via the control terminals and/or serial communication. See also *Auto start*.

Hand mode (HAND)

The frequency converter is in Hand mode, i.e. control is carried out via the control keys. See *Hand start*.

OFF (OFF)

OFF/STOP is activated either by means of the control key, or by the digital inputs *Hand start* and *Auto start* both being a logic "0". See also *OFF/STOP*

Local reference (LOCAL)

If LOCAL has been selected, the reference is set via the [+/-] keys on the control panel. See also *Display modes*.

Remote reference (REM.)

If REMOTE has been selected, the reference is set via the control terminals or via serial communication. See also *Display modes*.

Running (RUNNING)

The motor speed now corresponds to the resulting reference.

Ramp operation (RAMPING)

The output frequency is now changed in accordance with the preset ramps.

Auto-ramp (AUTO RAMP)

Parameter 208 *Automatic ramp-up/down* is enabled, i.e. the frequency converter is trying to avoid a trip from overvoltage by increasing its output frequency.

Sleep Boost (SLEEP .BST)

The boost function in parameter 406 *Boost setpoint* is enabled. This function is only possible in *Closed loop* operation.

Sleep mode (SLEEP)

The energy saving function in parameter 403 *Sleep mode timer* is enabled. This means that at present the motor has stopped, but that it will restart automatically when required.

Start delay (START DEL)

A start delay time has been programmed in parameter 111 *Start delay*. When the delay has passed, the output frequency will start by ramping up to the reference.

Run request (RUN REQ.)

A start command has been given, but the motor will be stopped until a Run permissive signal is received via a digital input.

Jogging (JOG)

Jog has been enabled via a digital input or via serial communication.

Jog request (JOG REQ.)

A JOG command has been given, but the motor will remain stopped until a *Run permissive* signal is received via a digital input.

Freeze output (FRZ.OUT.)

Freeze output has been enabled via a digital input.

Freeze output request (FRZ.REQ.)

A freeze output command has been given, but the motor will remain stopped until a Run permissive signal is received via a digital input.

Reversing and start (START F/R)

Reversing and start [2] on terminal 19 (parameter 303 *Digital inputs*) and *Start* [1] on terminal 18 (parameter 302 *Digital inputs*) are enabled at the

All about VLT 6000 HVAC

same time. The motor will remain stopped until one of the signals becomes a logic '0'.

Automatic Motor Adaptation running (AMA RUN)

Automatic motor adaptation has been enabled in parameter 107 *Automatic Motor Adaptation, AMA*.

Automatic Motor Adaptation completed (AMA STOP)

Automatic motor adaptation has been completed. The frequency converter is now ready for operation after the *Reset* signal has been enabled. Please note that the motor will start after the frequency converter has received the *Reset* signal.

Stand by (STANDBY)

The frequency converter is able to start the motor when a start command is received.

Stop (STOP)

The motor has been stopped via a stop signal from a digital input, [OFF/STOP]-button or serial communication.

DC stop (DC STOP)

The DC brake in parameter 114-116 has been enabled.

DRIVE ready (UN. READY)

The frequency converter is ready for operation, but terminal 27 is a logic "0" and/or a *Coasting command* has been received via the serial communication.

Not ready (NOT READY)

The frequency converter is not ready for operation, because of a trip or because OFF1, OFF2 or OFF3 is a logic '0'.

Start disabled (START IN.)

This status will only be displayed if, in parameter 599 *Statemachine, Profidrive* [1] has been selected and OFF2 or OFF3 is a logic '0'.

Exceptions XXXX (EXCEPTIONS XXXX)

The microprocessor of the control card has stopped and the frequency converter is out of operation. The cause may be noise on the mains, motor or control cables, leading to a stop of the control card microprocessor. Check for EMC-correct connection of these cables.

■ List of warnings and alarms

The table gives the different warnings and alarms and indicates whether the fault locks the frequency converter. After Trip locked, the mains supply must be cut and the fault must be corrected. Reconnect the mains supply and reset the frequency converter before being ready. A Trip can be reset manually in three ways

1. Via the control key [RESET]
2. Via a digital input
3. Via serial communication In addition, an automatic reset may be selected in parameter 400 *Reset function*.

Wherever a cross is placed under both Warning and Alarm, this can mean that a warning precedes the alarm. It can also mean that it is possible to program whether a given fault is to result in a warning or an alarm. This is possible, e.g. in parameter 117 *Motor thermal protection*. After a trip, the motor will be coasting and on the frequency converter alarm and warning will flash. If the fault is removed, only the alarm will flash. After a reset, the frequency converter will be ready to start operation again.

No.	Description	Warning	Alarm	Trip locked
1	10 Volts low (10 VOLT LOW)	x		
2	Live zero fault (LIVE ZERO ERROR)	x	x	
4	Mains imbalance (MAINS IMBALANCE)	x	x	x
5	Voltage warning high (DC LINK VOLTAGE HIGH)	x		
6	Voltage warning low (DC LINK VOLTAGE LOW)	x		
7	Overvoltage (DC LINK OVERVOLT)	x	x	
8	Undervoltage (DC LINK UNDERVOLT)	x	x	
9	Inverter overloaded (INVERTER TIME)	x	x	
10	Motor overloaded (MOTOR TIME)	x	x	
11	Motor thermistor (MOTOR THERMISTOR)	x	x	
12	Current limit (CURRENT LIMIT)	x	x	
13	Overcurrent (OVERCURRENT)	x	x	x
14	Earth fault (EARTH FAULT)		x	x
15	Switch mode fault (SWITCH MODE FAULT)		x	x
16	Short-circuit (CURR.SHORT CIRCUIT)		x	x
17	Serial communication timeout (STD BUSTIMEOUT)	x	x	
18	HPFB bus timeout (HPFB TIMEOUT)	x	x	
19	Fault in EEprom on power card (EE ERROR POWER)	x		
20	Fault in EEprom on control card (EE ERROR CONTROL)	x		
22	Auto-optimisation not OK (AMA FAULT)		x	
29	Heat-sink temperature too high (HEAT SINK OVERTEMP.)		x	
30	Motor phase U missing (MISSING MOT.PHASE U)		x	
31	Motor phase V missing (MISSING MOT.PHASE V)		x	
32	Motor phase W missing (MISSING MOT.PHASE W)		x	
34	HPFB communication fault (HPFB COMM. FAULT)	x	x	
37	Inverter fault (GATE DRIVE FAULT)		x	x
39	Check parameters 104 and 106 (CHECK P.104 & P.106)	x		
40	Check parameters 103 and 105 (CHECK P.103 & P.106)	x		
41	Motor too big (MOTOR TOO BIG)	x		
42	Motor too small (MOTOR TOO SMALL)	x		
60	Safety stop (EXTERNAL FAULT)		x	
61	Output frequency low (FOUT < FLOW)	x		
62	Output frequency high (FOUT > FHIGH)	x		
63	Output current low (I MOTOR < I LOW)	x	x	
64	Output current high (I MOTOR > I HIGH)	x		
65	Feedback low (FEEDBACK < FDB LOW)	x		
66	Feedback high (FEEDBACK > FDB HIGH)	x		
67	Reference low (REF. < REF. LOW)	x		
68	Reference high (REF. > REF. HIGH)	x		
69	Temperature auto derate (TEMP.AUTO DERATE)	x		
80	Fire mode was active (FIRE MODE WAS ACTIVE)	x	x	
81	RTC not ready (RTC NOT READY)	x		
99	Unknown fault (UNKNOWN ALARM)		x	x

■ Index
C

control panel - LCP	18
Cable clamp	12
Cables	7
Changing data	23
Connection examples	16
Control card	15
Control keys	18
Control unit LCP	18
Cooling	4

D

direction of motor rotation	14
DC bus connection	15
Direction of motor rotation	14
Display	18
Display mode	19

E

earthing	12
Earth connection	15
Earthing	7
Electrical installation - earthing of control cables	12
Equalising cable,	12
Extra protection	7

G

General warning	2
-----------------------	---

H

Heat emission from VLT 6000 HVAC	11
High voltage test	11
High voltage warning	7
High-voltage relay	15

I

IT mains	9
Indicator lamps	18, 19
Initialisation	23

L

Local control	19
Local Control Panel	18

M

Mains connection	13
------------------------	----

Mechanical installation	4
Motor cables	14
Motor connection	13
Motor thermal protection	15

P

Parallel coupling	14
PLC	12
Pre-fuses	13

Q

Quick Menu	24
------------------	----

R

RFI switch	9
------------------	---

S

screw sizes	13
Safety regulations	2
Screened/armoured cables	7
serial communication	12
Status messages	25

T

Tightening-up torque	13
Trip locked	27

U

Unintended start	2
------------------------	---

V

Ventilation of integrated VLT 6000 HVAC	11
---	----

W

Warning	3
Warning against unintended start	2
Warnings and alarms	27